

Pimoroni Pico Plus 2 (PIM724)

RP2350B MCU

MCU2

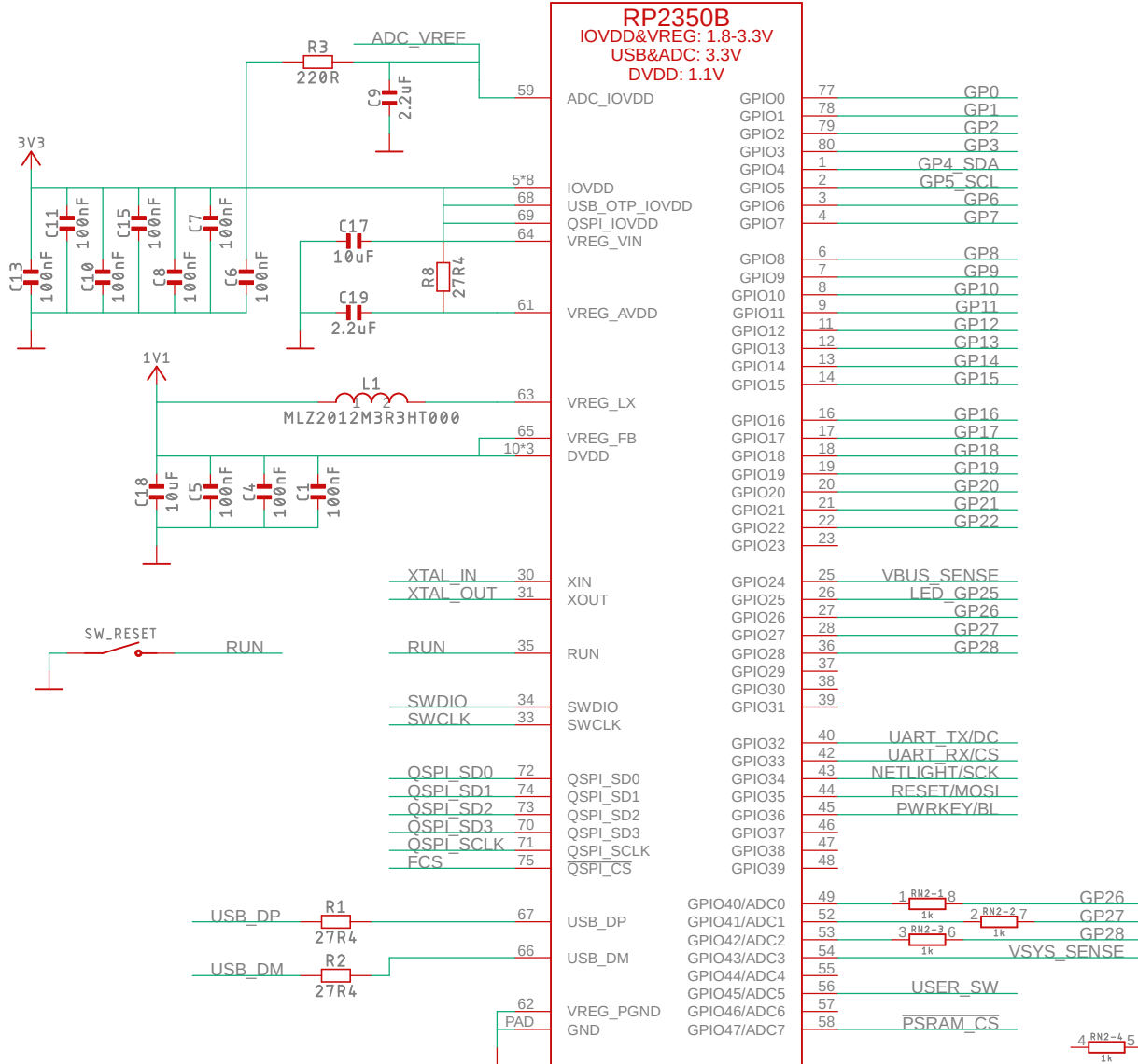

SP/CE connector

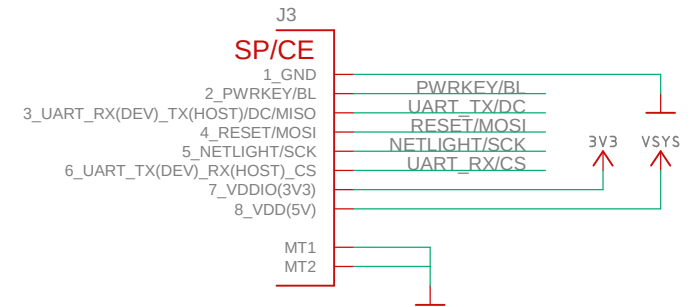

Pimoroni Pico Plus 2 (PIM724)

USB-C connector

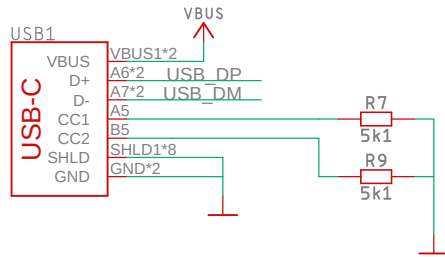

User LED

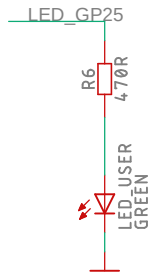

Vbus sense voltage divider

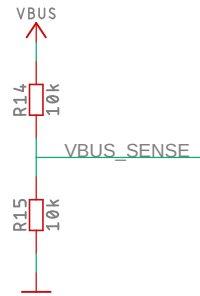

Vsys sense voltage divider

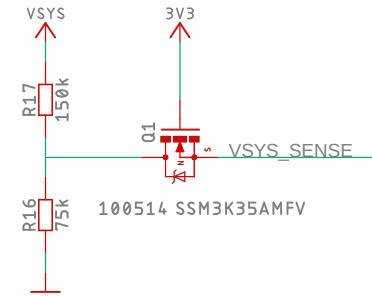

Vbus to Vsys diode connection

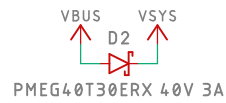

PSRAM

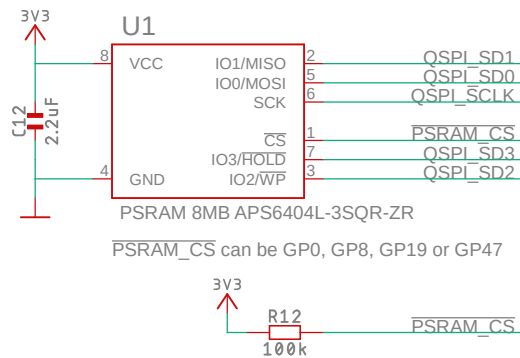

Debug connector

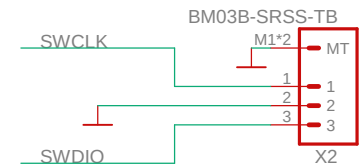

LDO for 3V3 output, low Iq

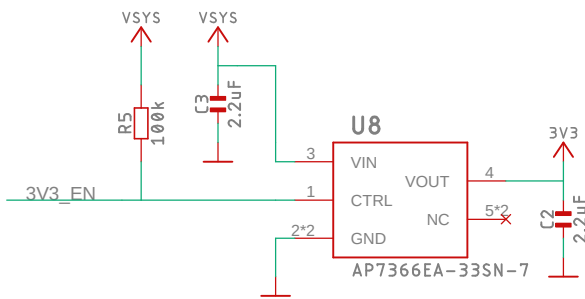

QW/ST connector

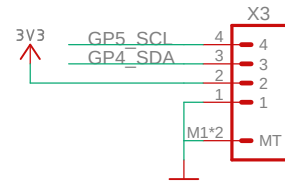

Crystal oscillator

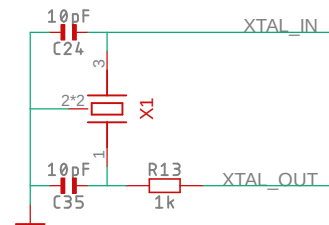

Flash memory

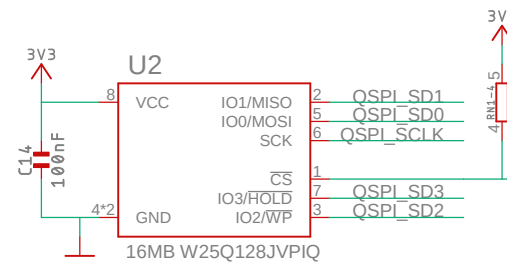

Combined USB boot & user switch

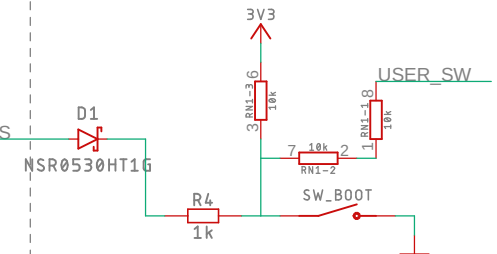

Pimoroni Pico Plus 2 (PIM724)

Output headers

