

## Digital RGB COB LED Strip – 180LEDs/m



### ◆ Product Description:

- High density, the light is even and soft
- High efficiency, remarkable energy saving effect
- Double layer PCB, balancing voltage drop, heat dissipation and flexibility.
- Chip longitudinal distribution, high reliability;
- Standard 1M/roll, length can be customized



### ◆ Product Datasheet

Product Number	S010180ZA3SF
Operating Voltage	DC5V
Power/m	5W
SMD Type	COB
LED Qty/m	180
Color	RGB
Luminance/m	R: 62 G:182 B:34 lm
Wavelength	R:615-630 G:520-535 B:450-460 nm
Control	SPI-WS2811
Beam Angle	180°
Size	1000x10mm
IP Rate	IP65
Operation Temperature	- 25 ~ 60°C

#### Remarks:

- 1.The above parameters were tested according to integrating sphere TM-30-15.
- 2.The output data is based on IP20 and one merter.
- 3.The data such as power etc, ±15% tolerance is normal.
- 4.IP protection process causes changes in size, CCT and luminous flux.

## Outline Dimension (unit:mm)

DC5V

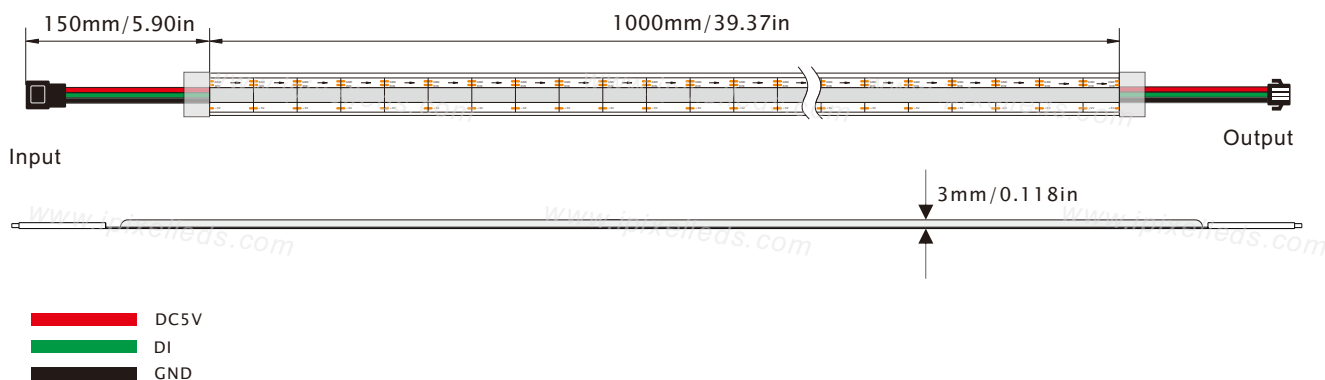

## Wiring diagram

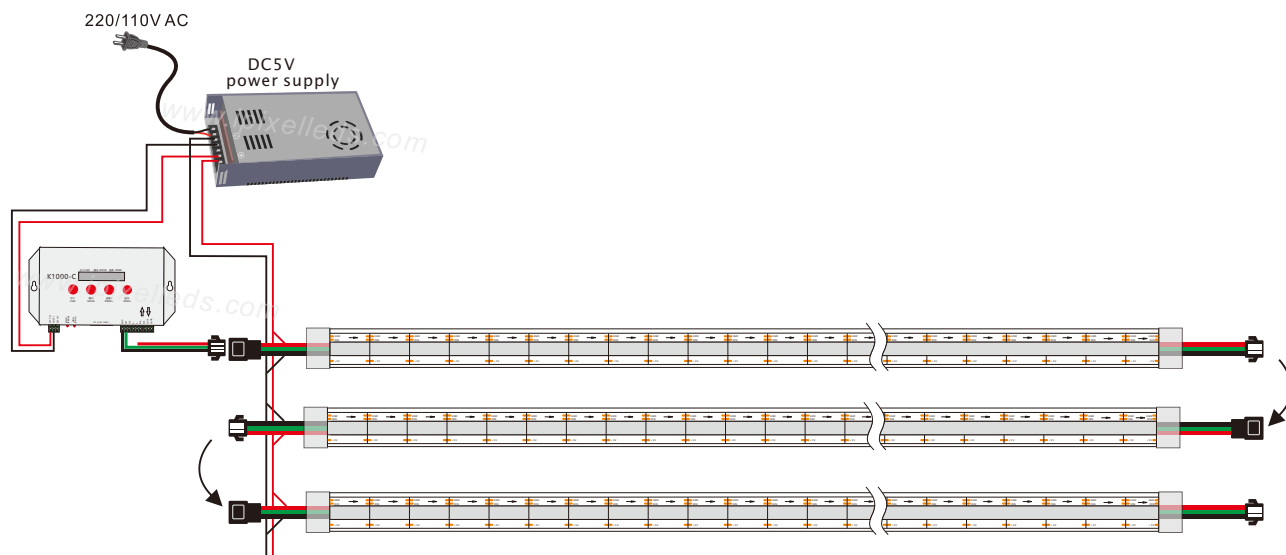

## IP Rate

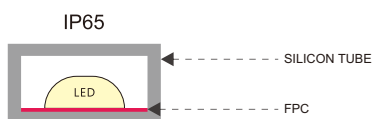

## ◆ Related products



Power supply  
LRS-350-24



K-1000C

## ◆ Schematic diagram of maximum bending prevention

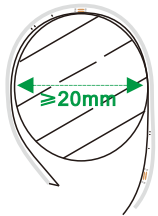

Bending diameter  $\geq 20\text{mm}$

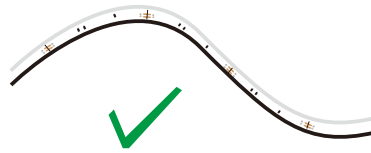

Correct bending method

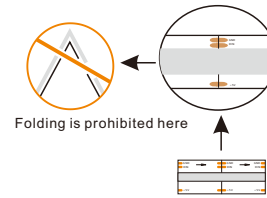

Wrong method

## ◆ Product packaging



Reel



Antistatic bag

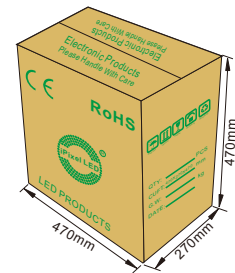

Note: The parameters are subject to change without notice!

A1.24-01-26