

序号	部件名称	使用材质	序号	部件名称	使用材质
01	锁壳	锌合金	07	脚座	塑料
02	锁芯	锌合金	08	导电脚	黄铜
03	螺母	锌合金	09	导电轴	黄铜
04	钥匙	锌合金	10	导电弹簧	碳素钢丝
05	钥匙套	塑料	11	钥匙圈	304不锈钢
06	转件	塑料	12		

孔位推荐尺寸

$10.8^{+0.1}_0$

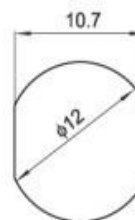
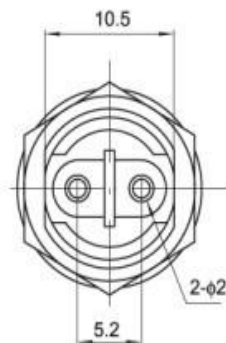
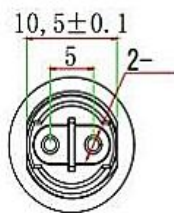
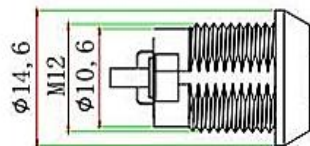
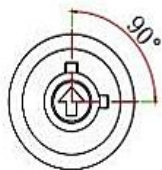
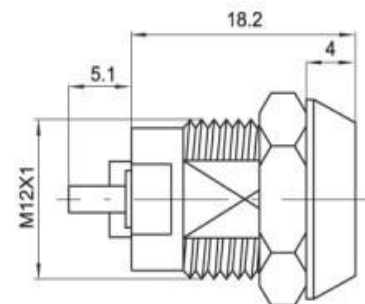
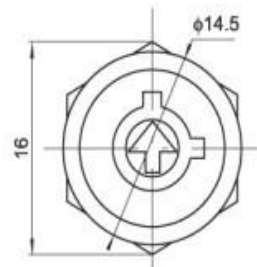
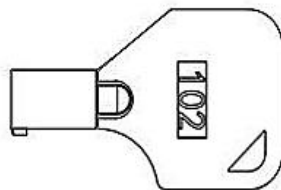
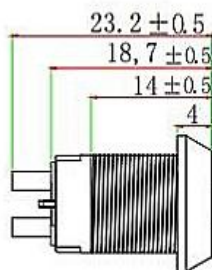
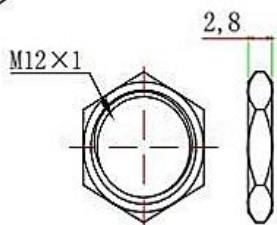
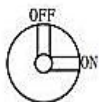
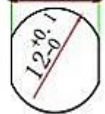

技术要求:

- 1、表面要求: 无裂纹、缺料、损坏伤痕、电镀缺陷等;
- 2、功能介绍: 90° 两档双拔, 开与关运作;
- 3、安装方式: 螺母紧固方式安装;
- 4、未注公差: GB/T 1804-2000-m级 (带★为关键作用尺寸);
- 5、表面处理: 根据各零部件图纸或客户要求.