



上海冠显光电科技有限公司
Shanghai Top Display Optoelectronics Co., LTD

**PRODUCTION SPECIFICATION
OF LCD MODULE
MODULE NO.: TL032FWV01-I1440A**

Customer Name:			
Customer Part Number:			
Approved By:		Date:	

Prepared By	Checked By	Approved By



Table of Contents

Revision History.....	3
1 General Specifications.....	4
2 Pin Assignment.....	5
3 Absolute Maximum Ratings.....	6
4 Electrical Characteristics.....	6
5 INTERFACE TIMING.....	8
5.1 RGB interface.....	8
5.2 Power ON/OFF Timing.....	9
6 Optical Characteristics.....	10
7 Environmental / Reliability Test.....	14
8 Mechanical Drawing.....	15
9 Precautions For Use of LCD Modules.....	16



Revision History

Rev.	Issued Date	Description	Page	Editor
1.0	Feb. 22,2020	First release	All	



1 General Specifications

	Feature	Specifications
Display Spec.	Display Size(Diagonal)	3.16 inch
	Resolution (H*V)	320(RGB) × 820
	LCD type	a-Si TFT
	Pixel Configuration	R.G.B. Vertical Stripe
	Display Mode	IPS/Transmissive/Normally Black
	Viewing Direction	All
Mechanical Characteristics	OutlineDimensions (H xV x T) (mm)	31.2(H) ×76.6(V)×2.4(T)
	Active Area(mm)	26.4 (H)×67.65(V)
	With /Without Touch screen	Without
	Match Connector Type	0.5 PITCH 40PIN
	Backlight Type	White LED
	Weight (g)	TBD
Electrical Characteristics	Interface	3SPI+18RGB
	Number of color	262K
	Driver IC	ST7701S



2 Pin Assignment

1	LED A	LED ANODE
2	LED K	LED CATHODE
3	LED K	LED CATHODE
4	GND	Ground
5	VCI	Power supply
6	RESET	Reset Signal ,Active Low
7	TE	Tearing effect output pin to synchronize MPU to frame writing
8	PWM	The PWM frequency output for LCD driver control.
9	SDA	SPI Data signal
10	SCK	SPI Clock signal
11	CS	SPI Chip select signal
12	PCLK	RGB dot clock signal
13	DE	RGB data enable signal
14	VSYNC	RGB frame synchronizing signal
15	HSYNC	RGB line synchronizing signal
16~33	DB0~DB17	RGB data signal (DB0:BLUE LSB;DB5:BLUE MSB;DB6:GREEN LSB;DB11:GREEN, MSB;DB12:RED LSB;DB17:RED MSB)
34	GND	Ground
35	TP_INT	Touch Interrupt
36	TP_SDA	Touch IIC Data signal
37	TP_SCL	Touch IIC Clock signal
38	TP_RESET	Touch Reset Signal
39	TP_VCI	Touch Power supply
40	GND	Ground

3 Absolute Maximum Ratings

GND=0V, Ta= 25°C

Item	Symbol	Value	Unit
Power supply voltage for logic	V _{DD}	0.3~4.8	V
Input voltage	V _{in}	V _{DD} +0.3	V
Operating temperature	T _{opr}	-20 to 70	°C
Storage temperature	T _{stg}	-30 to 80	°C

4 Electrical Characteristics

4.1 DC Characteristics (VDD=2.8V,Ta=25°C)

Item	Symbol	Min	Type	Max	Unit	Test condition
Operating voltage	V _{DD}	2.5	2.8	4.8	V	-
Supply current	I _{DD}	-	-	25	mA	V _{DD} =2.8V,Ta=25°C
Input voltage	V _{IH}	0.8V _{DD}	-	V _{DD}	V	-
	V _{IL}	0	-	0.2V _{DD}	V	
Input leakage current	I _{IL}	-1.0	-	1.0	μA	V _{IN} =V _{DD} or V _{SS}

Note: Voltage greater than above may damage the module.

All voltages are specified relative to VSS=0V.

4.2 Driving Backlight

Ta=25°C

Item	Symbol	Min	Typ	Max	Unit	Remark
Forward Current	I _F	--	20		mA	
Forward Voltage	V _F	-	12.8	-	V	
Connection mode	P	--	4S1P	--		
LED number	/		4		pcs	
LED life time		20000			hours	

Note1: Optical performance should be evaluated at Ta=25°C only .If LED is driven by high current, high ambient temperature & humidity condition. The life time of LED will be reduced. Operating life means brightness goes down to 50% initial brightness. Typical operating life time is estimated data.

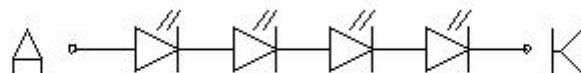

4.3 Block Diagram

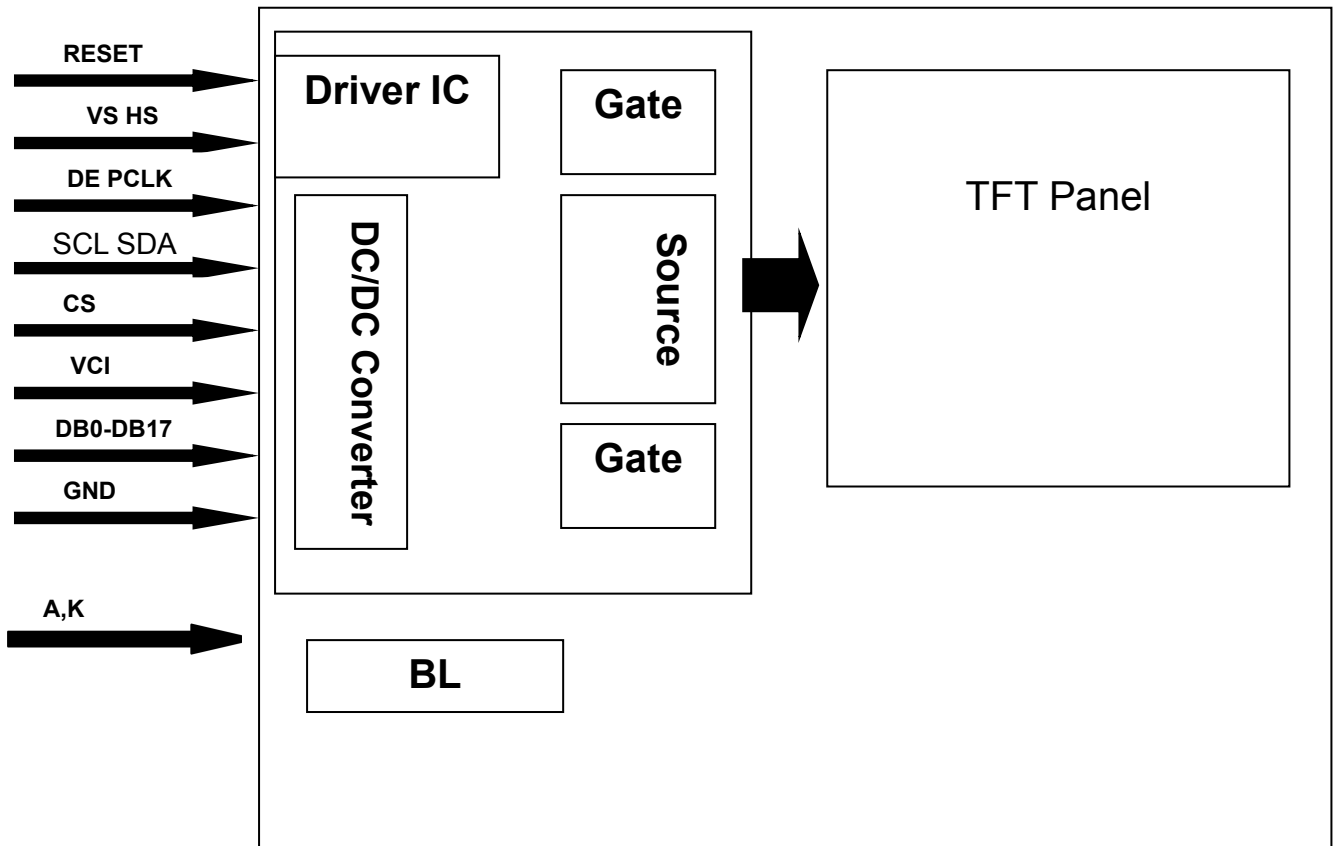

5 INTERFACE TIMING

5.1 RGB interface

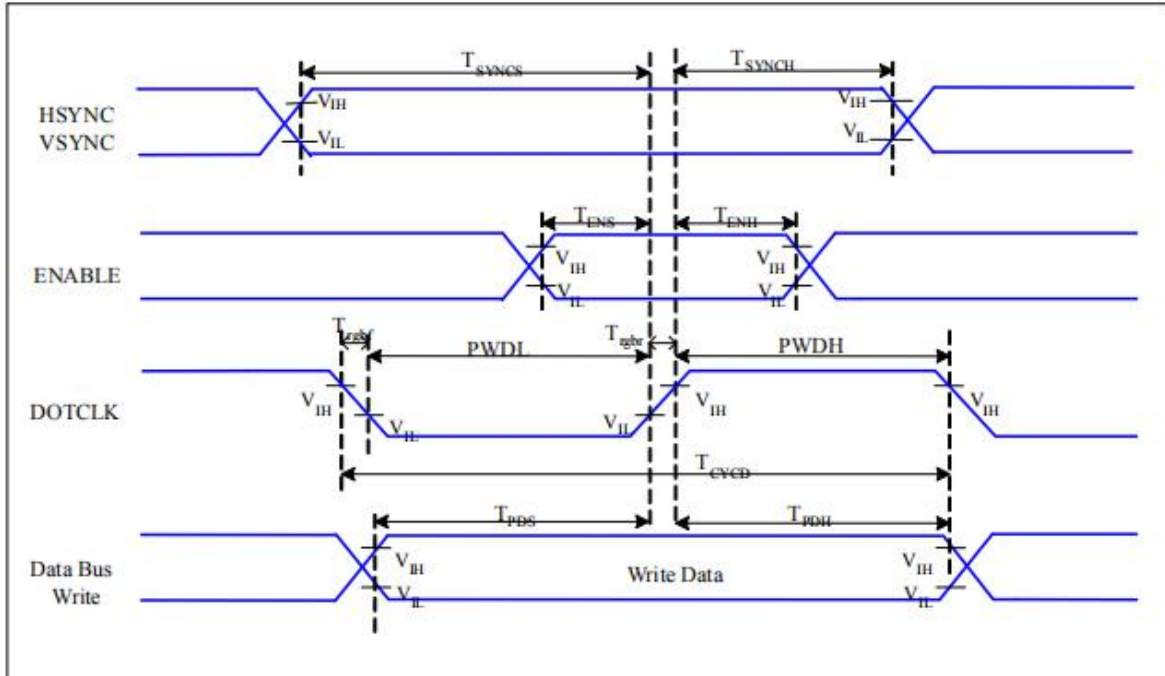
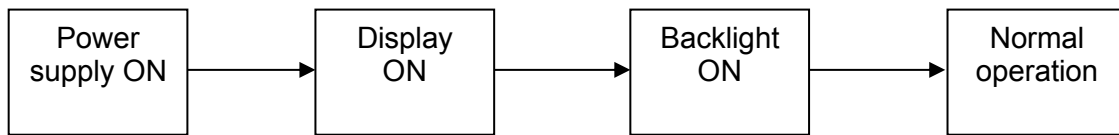
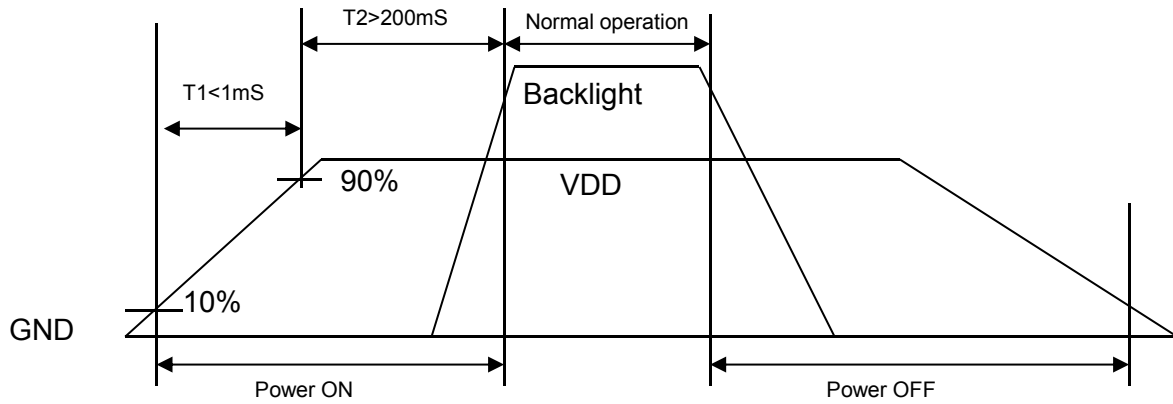

Figure 3 RGB Interface Timing Characteristics

VDDI=1.8, VDD=2.8, AGND=DGND=0V, Ta=25 °C

Signal	Symbol	Parameter	MIN	MAX	Unit	Description
HSYNC, VSYNC	T_{SYNCS}	VSYNC, HSYNC Setup Time	5	-	ns	
ENABLE	T_{ENS}	Enable Setup Time	5	-	ns	
	T_{ENH}	Enable Hold Time	5	-	ns	
DOTCLK	PWDH	DOTCLK High-level Pulse Width	15	-	ns	
	PWDL	DOTCLK Low-level Pulse Width	15	-	ns	
	T_{CycD}	DOTCLK Cycle Time	33	-	ns	
	Trghr, Trghf	DOTCLK Rise/Fall time	-	15	ns	
DB	T_{PDS}	PD Data Setup Time	5	-	ns	
	T_{PDH}	PD Data Hold Time	5	-	ns	

5.2 Power ON/OFF Timing



Power ON sequence

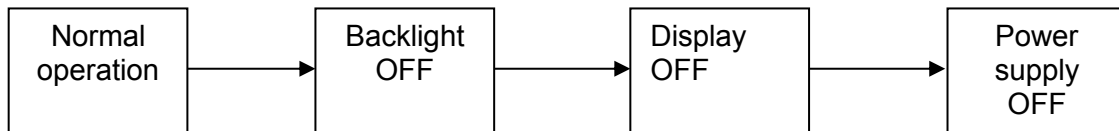

Power OFF sequence



6 Optical Characteristics

Ta=25°C

Item	Symbol	Condition	Min	Typ	Max	Unit	Remark
View Angles	θT	$CR \cong 10$		80	-	Degree	Note 2
	θB			80	-		
	θL			80	-		
	θR			80	-		
Contrast Ratio	CR	$\theta=0^\circ$		900	-	-	Note1 Note3
Response Time	T_{ON}	25°C	-	30	35	ms	Note1 Note4
	T_{OFF}						
Uniformity	U	-	80	85	-	%	Note1 Note6
NTSC	-	-	-	60	-	%	Note 5
Luminance	L		250	300	-	cd/m ²	Note1 Note7

Test Conditions:

1. $V_F=12.8V$, $I_F=20mA$, the ambient temperature is 25°C.
2. The test systems refer to Note 1 and Note 2.

Note 1: Definition of optical measurement system.

The optical characteristics should be measured in dark room. After 5 minutes operation, the optical properties are measured at the center point of the LCD screen. All input terminals LCD panel must be ground when measuring the center area of the panel.

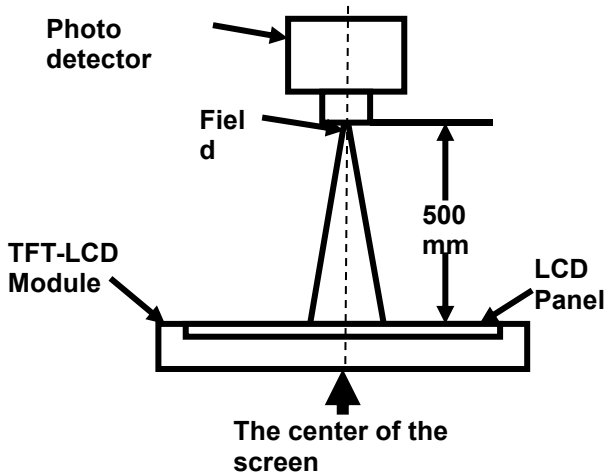

Item	Photo detector	Field
Contrast Ratio	SR-3A	1°
Luminance		
Chromaticity		
Lum Uniformity		
Response Time	BM-7A	2°

Note 2: Definition of viewing angle range and measurement system.

viewing angle is measured at the center point of the LCD by CONOSCOPE(ergo-80).

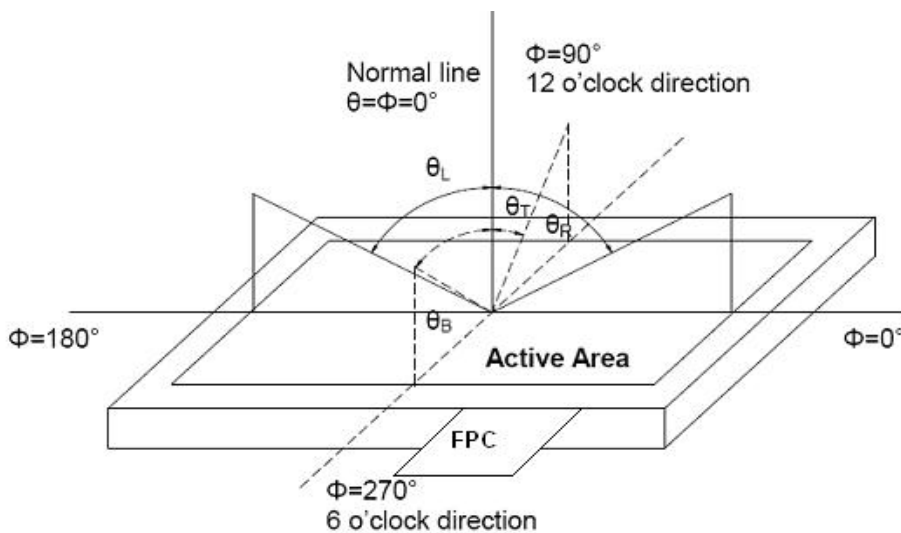

Fig. 1 Definition of viewing angle

Note 3: Definition of contrast ratio

$$\text{Contrast ratio (CR)} = \frac{\text{Luminance measured when LCD is on the "White" state}}{\text{Luminance measured when LCD is on the "Black" state}}$$

“White state “:The state is that the LCD should be driven by Vwhite.

“Black state”: The state is that the LCD should be driven by Vblack.

Vwhite: To be determined Vblack: To be determined.

Note 4: Definition of Response time

The response time is defined as the LCD optical switching time interval between “White” state and “Black” state. Rise time (TON) is the time between photo detector output intensity changed from 90% to 10%. And fall time (TOFF) is the time between photo detector output intensity changed from 10% to 90%.

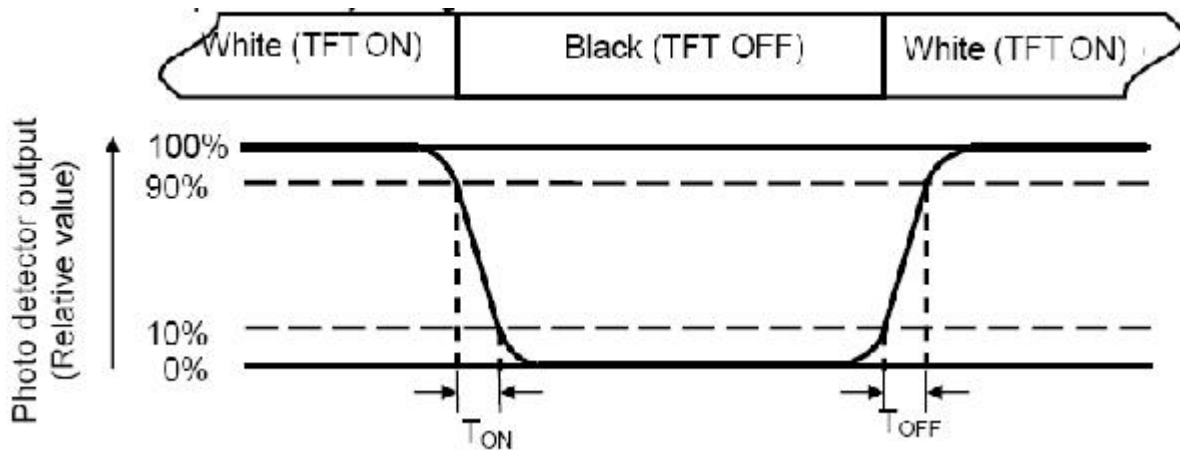

Note 5: Definition of color chromaticity (CIE1931)

Color coordinates measured at center point of LCD.

Note 6: Definition of Luminance Uniformity

Active area is divided into 9 measuring areas (Refer Fig. 2). Every measuring point is placed at the center of each measuring area.

Luminance Uniformity (U) = L_{min} / L_{max}

L-----Active area length W----- Active area width

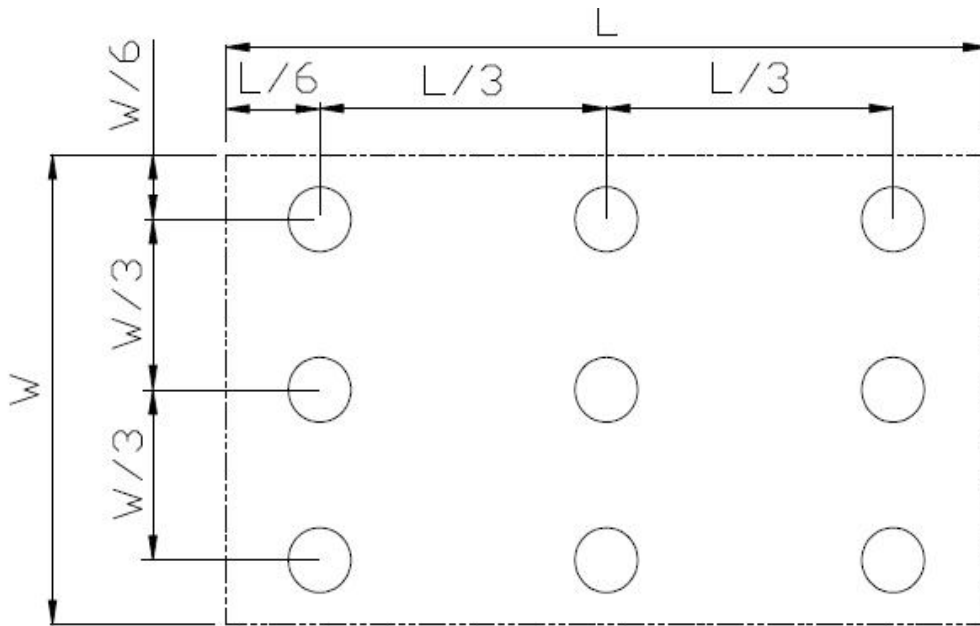

Fig. 2 Definition of uniformity

L_{max} : The measured maximum luminance of all measurement position.

L_{min} : The measured minimum luminance of all measurement position.

Note 7: Definition of Luminance:

Measure the luminance of white state at center point.



7 Environmental / Reliability Test

Item	Condition	Time (hrs)	Assessment
High temp. Storage	80°C	120	No abnormalities in functions and appearance
High temp. Operating	70°C	120	
Low temp. Storage	-30°C	120	
Low temp. Operating	-20°C	120	
Humidity	40°C/ 90%RH	120	
Thermal Shock(Non-operation)	-20°C ← 25°C →70°C (0.5 hour ← 5 min → 0.5 hour)	10cycles	

Remark:

- 1.The test samples should be applied to only one test item.
- 2.Sample size for each test item is 1~10pcs.
- 3.In case of malfunction defect caused by ESD damage, if it would be recovered to normal state after resetting, it would be judged as a good part.

8 Mechanical Drawing

1	2	3	4	5	6	7	8
上海冠显光电科技有限公司 Top Display Optoelectronics Co., LTD Date: (日期) 2019.12.18 Page: (页数) 1/1 图纸视角:		DESIGN: (设计) APPROVED: (检查) CHECKED: (批准) SPECIFICATION CUSTOMER'S CODE: (客户型号) TDO'S CODE: (冠显料号)		规格 TL032FWV01-I1440A EDITION: (版本号) EDITION: (版本号) 01		PIN: SYMBLE 1 LEDA 2 LEDK 3 LEDK 4 GND 5 VCI 6 RESET 7 TE 8 PWM 9 SDA 10 SCK 11 CS 12 PCLK 13 DE 14 VSYNC 15 HSYNC 16 ³³ DE0 ^{DBI7} 34 GND 35 TP_INT 36 TP_SDA 37 TP_SCL 38 TP_RESET 39 TP_VCI 40 GND	
A		B		C		D	
<p> 76.60±0.20 LCM 67.65 LCD AA 31.25±0.20 LCM 24.00 LCD AA 2.40 2.45±0.15 0.30±0.03 4.48 20.50 1.55 35.00 3.16" 3.00±0.05±0.20 TP_INT-INT TP_SDA-SDA TP_SCL-SCL TP_RESET-RESET TP_VCI-VCI 0.35(40-1)±0.1±0.3 20.50 3.50 0.35 </p>							
1LED引脚: A---B---C---K							
1 Unit:mm. 2. All Modification rev.number. 3. All radii without dimension R0.3mm. 4. All draft angles to be 1.5°. 5. Unspecified Tolerances is : ±0.20mm. 6. Driver IC: ST7701S 7. Color : White 8. Operating Temperature : -20°- +70°C 9. Storage Temperature : -30° - +80° C 10. Requirements on Environmental Protection: ROHS HSF							
Customer Name: 客户名称		Approval Date: 承认日期		Approved By: 承认		Please Confirm This Drawing On/Before 请签回此图	
1	2	3	4	5	6	7	8



9 Precautions For Use of LCD Modules

9.1 Handling Precautions

9.1.1.1 The display panel is made of glass. Do not subject it to a mechanical shock by dropping it from a high place, etc.

9.1.1.2 If the display panel is damaged and the liquid crystal substance inside it leaks out, be sure not to get any in your mouth, if the substance comes into contact with your skin or clothes, promptly wash it off using soap and water.

9.1.1.3 Do not apply excessive force to the display surface or the adjoining areas since this may cause the color tone to vary.

9.1.1.4 The polarizer covering the display surface of the LCD module is soft and easily scratched. Handle this polarizer carefully.

9.1.1.5 If the display surface is contaminated, breathe on the surface and gently wipe it with a soft dry cloth. If still not completely clear, moisten cloth with one of the following solvents:

- Isopropyl alcohol
- Ethyl alcohol

Solvents other than those mentioned above may damage the polarizer. Especially, do not use the following:

- Water
- Ketone
- Aromatic solvents

9.1.1.6 Do not attempt to disassemble the LCD Module.

9.1.1.7 If the logic circuit power is off, do not apply the input signals.

9.1.1.8 To prevent destruction of the elements by static electricity, be careful to maintain an optimum work environment.

9.1.1.9 Be sure to ground the body when handling the LCD Modules.

9.1.1.10 Tools required for assembly, such as soldering irons, must be properly ground.

9.1.1.11 To reduce the amount of static electricity generated, do not conduct assembly and other work under dry conditions.

9.1.1.12 The LCD Module is coated with a film to protect the display surface. Be care when peeling off this protective film since static electricity may be generated.

9.1.1.13 Storage precautions

9.1.1.14 When storing the LCD modules, avoid exposure to direct sunlight or to the light of fluorescent lamps.

9.1.1.15 The LCD modules should be stored under the storage temperature range. If the LCD modules will be stored for a long time, the recommend condition is:

9.1.1.16 The LCD modules should be stored in the room without acid, alkali and harmful gas.

9.2 Transportation Precautions

The LCD modules should be no falling and violent shocking during transportation, and also should avoid excessive press, water, damp and sunshine.