

承认书



Specification For Delivery

RoHS

客户

CUSTOMER

—

部品番号

XSG-0504000HUS

PART NUMBER

版本号: A0

客户承认回签 Customer Approval

担当者	审核	承认	公司承认章

新赛科技有限公司

SHENZHEN SUNSHINE TECHNOLOGICS CO.,LTD.

地址:深圳市宝安区松岗田洋二路南边头科技园 B 栋
电话:0755-27081806/23579378 传真:0755-23579379

营业担当
SALES



新赛品名
X.S. P/N

技术担当
ENGINEER



责任人
RESPONSIBILITY



Table of contents

目录

安规标准 / SAFETY STANDARD.....	P3
输入特性 / INPUT CHARACTERIST.....	P3
输出特性 / OUTPUT CHARACTERIST.....	P4
保护功能 / PROTECTION FUNCTION.....	P5
环境要求 / ENVIRONMENTAL REQUIREMET.....	P5、 6
电磁兼容性标准 / EMC STANDARDS.....	P7
测量设备 / MAJOR MEASURE EQUIPMENT.....	P7
产品外观尺寸 / PRODUCT OUTLINE	P8
线材 / DC CORD.....	P9
铭板 / RATING LABEL.....	P10
包装图 / PACRING.....	P11

UPDATE REV.

REV	UPDATE	DATE	PRERARATOR
original		2023.08.09	陈海英



1、安规标准/ SAFETY STANDARD:

1.1 The green mode power supply shall be certified by the following international regulatory standards: 电源应符合下列的国际标准:

<input type="checkbox"/>		Country	CertifiedStatus	Standard / 標準
<input type="checkbox"/>	PSE	Japan / 日本	APPROVED	J62368, J55022
<input checked="" type="checkbox"/>	UL	USA / 美國	APPROVED	UL 62368-1: 2007
<input type="checkbox"/>	cUL	CAN / 加拿大	APPROVED	CAN/CSA-C22.2 No. 62368-1 (2007)
<input checked="" type="checkbox"/>	FCC	USA / 美國	APPROVED	Part 15 Class B
<input type="checkbox"/>	CE	Europe / 歐洲	APPROVED	EN 55032:55035/EN 62368-1/EN 61558-1/EN 61558-2-16
<input type="checkbox"/>	GS	Europe / 德國	APPROVED	EN 62368-1/EN 61558-1/EN 61558-2-16/AfP GS 2 1
<input type="checkbox"/>	BS	UK / 英國	APPROVED	BS EN 62368-1/BS EN 61558-1/BS EN 61558-2-16
<input type="checkbox"/>	SAA	Australia / 澳洲	APPROVED	AS/NZS 62368-1:2011& AS/NZS 3112:2011
<input type="checkbox"/>	CCC	CN / 中国	APPROVED	GB4943-2001,GB1317625.1-2003
<input type="checkbox"/>	KC	KC/韩规	APPROVED	HU10898-16001C

2、INPUT CHARACTERIST / 输入特性:

2.1 输入电压范围可以从 **90Vac** 到 **264Vac**.

INPUT VOLTAGE RANGE: **90Vac** to **264Vac**.

2.2 额定输入电压从 **100Vac** 到 **240Vac**.

RATED INPUT VOLTAGE: **100Vac** to **240Vac**.

2.3 输入频率范围从 **47Hz** 到 **63Hz**.

INPUT FREQUENCY RANGE: **47Hz** to **63Hz**.

2.4 最大输入电流不超过 **0.8A** (输入条件 100-240Vac)

INPUT CURRENT: **0.8A** max. (I/P100-240Vac).

2.5 在标准开机条件下, 最大浪涌电流不超过 **50A** (输入条件 **100-240Vac**).

INRUSH CURRENT: **50A** max. at **100-240Vac** input for a cold start at 25°C.



3、输出特性/ OUTPUT CHARACTERIST:

3.1 输出功率/ Power output

额定输出 RATED OUTPUT	最小负载 Min. Load	额定输出负载 Rated Output Load	输出功率 Output power	空载功耗 No Load Power consumption
5VDC	0 A	4A	20W	0.1W

3.2 负载特性/ Combined Load

额定输出 RATED OUTPUT	最小负载 Min. Load	额定输出负载 Rated Output Load	线性调整 Line Regulation	负载调整 Load Regulation
5 VDC	0 A	4 A	±3%	±5% (4.95V-5.60V)

3.3 平均效率高于 83.08% (输入 100-240Vac, 输出 (25%, 50%, 75%&100%负载))

Higher than 83.08 % at 100-240Vac input and output (25%, 50%, 75% & 100% load.)

3.4 纹波和噪音 Ripple and Noise:

测试条件:在额定电压及额定负载条件下,使用示波器带宽为 20MHz 连接到充电器的输出端,同时输出端并联一个 10uF 的电解电容和一个 0.1uF 的瓷片电容.

Under nominal voltage and nominal load,the ripple and noise are as follows when measure with Max.Bandwidth of 20MHz and Parallel 10uF/0.1uF,crossed connected at testing point.

电压 / <u>Voltage</u>	最大纹波/最大噪音 / <u>Ripple and Noise(Max.)</u>
+5VDC	≤150mV p-p

3.5 启动延迟时间/Turn on delay time:

当输入 115Vac 和输出最大负载时,最大启动时间为 3S.

3Second Max.at 115Vac input and output Max.load.

3.6 保持时间/Hold up time:

当输入 115Vac 和输出最大负载时,最小保持时间为 5 mS .

5 mS Min.at 115Vac input and output Max.Load.

3.7 绝缘介电强度 (耐压) / ELECTRIC WITHSTANDING STRENGTH(HI-POT)

一次侧对二次侧: AC3300V/10mA 标准测试 1分钟, 量产测试 3秒钟

Primary to Secondary AC3300V/10mA , 1 minute for type test. 3 second for production.

3.8 过冲/Overshoot:

在电源开启或关闭的时候,最大 10%.

10% Max.When power supply at turn or turn off.

4、保护特性/PROTECTION FEATURE:

4.1 过电流保护 / OVER - CURRENT PROTECTION:

在任何时候任何输入条件，当输出操作在超载条件最大电源的（130~180%）时，电源供应器将进入打嗝模式，当故障被移走后，电源要能自动恢复到正常。

The green mode power supply shall be hiccupped when any output operating in overload condition(set@ Max load 130~180%) under any line condition for an indefinite period of time. The power supply shall be self - recovery when the fault condition is removed.

4.2 输出短路保护/ SHORT CIRCUIT PROTECTION:

在任何时候，任何输入条件下，当输出操作在短路情况下，电源供应器将进入打嗝模式，当故障消失后，电源要能自动恢复正常。

The power supply shall be hiccupped and no damage shall occur when any output operating in a short circuit condition under any line condition for an indefinite period of time. The power supply shall be self - recovery when the fault condition is removed.

5、环境条件 / ENVIRONMENTAL CONDITIONS:

5.1 操作条件 / OPERATING:

在下列环境条件下，电源供应器要能够连续操作在各种模式，且不能造成性能的退化。

The power supply shall be capable of operating continuously in any mode without performance deterioration in the following environmental conditions.

5.1.1 环境温度：0°C~40°C

Ambient Temperature: 0°C ~ 40°C

5.1.2 相对湿度：10%~90%

Relative Humidity: 10% ~ 90%

5.2 振动 / Vibration

测试标准：国际电工电子委员会

Operating: IEC 721-3-3 3M3 5~9Hz,A=1.5mm

加速度(9~200Hz,Acceleration 5m/S²)

5.3 冷却 / Cooling:

电源供应器将操作在对流冷却的环境下，即使将通风口阻塞电源也不允许有任何损伤发生。

The power supply will operate with convection cooling .Blocking of vents must not cause damage to The power supply.

6、储存条件 / Storage conditions:

电源供应器要能够长期的经受下列的环境条件，且不允许有电气级机械方面的损伤和并发的操作的缺失。

The power supply shall be capable of withstanding the following environmental conditions extended periods of time, without sustaining electrical or mechanical damage and subsequent operational deficiencies:

6.1.1 储存温度：-30°C~70°C

Storage Temperature: - 30°C ~ 70°C

6.1.2 相对湿度：10%~90%

Relative Humidity: 10% ~ 90%

6.2.3 振动和冲击 / Vibration and Shock:

电源供应器装配及出货的包装设计，均要能承受正常运输的振动，并符合 MIL-STD-810D 方法 514 和程序 X。

The power supply shall be designed to withstand normal transportation vibration per MIL-STD-810D, method 514 and procedures X, as it s mounted in the chassis assembly and packed for shipping.

7、可靠性及质量控制 / RELIABILITY AND QUALITY CONTROL:

7.1 老化 / BURN-IN

电源应在 40°C~±5°C 和满载条件下老化 2 小時。

The power supply shall undergo a minimum of 2 hours Burn-In test under full load at 40°C~±5°C

7.2 组件温度要求 / COMPONENT DERATING:

半导体结温不允许超过其制造商要求的最大温度值。

Semiconductor junction temperatures shall not exceed the manufacturer ' s maximum thermal rating.



8、电磁兼容性标准 / EMC STANDARDS:

8.1 EMI 标准 / EMI STANDARDS:

本电源供应器符合辐射及传导要求, 满足 FCC CLASS B, EN55022 CLASS B.

The power supply met the radiated and conducted emission requirements for FCC CLASS B.

8.2 EMS 标准 / EMS STANDARDS:

本电源供应器满足下列 EMS 标准

The power supply shall meet the following EMS standards:

EN 55035: 2017; Part 15 Subpart B, IC ICES-003

9、符合节能 6 级标准, 测试标准如下 / Energy Saving (Level VI / Level 6):

9.1 CEC Test Report (CEC Table U-2 Standards for Power Supplies Effective July 1, 2008)

9.2 EUP Test Report (COMMISSION REGULATION (EC) No 278/2009)

9.3 MEPS (AS/NZS 4665.2-2005)

10、绝缘阻抗 / INSULATION RESISTANCE:

输入对输出 50 兆 欧姆 (500VDC)

Input to output: 50M OHM(500VDC)

11、漏电流 / LEAKAGE CURRENT:

当电源供应器操作在最大输入及最大负载情况下, 其漏电流应小于 0.25mA, 满足 class II 等级。

The leakage current shall be less than 0.25mA for class II when power supply is operated maximum input voltage and maximum load.

12、主要测量设备 / MAJOR MEASURE EQUIPMENT:

A. AC SOURCE / 交流输入电源: AFC - 500W

B. POWER METER / 电源功率计: CHROMA 2100

C. ELECTRONIC LOAD / 电子负载: PRODIGIT 3310C

D. OSCILLOSCOPE / 存储示波器: TDS-2012B

E. DIGITAL MULTIMETER / 数字式万用表: Fluke 4.5

F. DC POWER / 直流输入电源: WYK - 6030

G. HI - POT TESTER / 耐压测试仪: LANKE ELECTRONICS 7112

H. INSULATION RASISTANCE TESTER / 绝缘电阻表: YD2681A



产品外观尺寸 / PRODUCT OUTLINE DIMENSION

mm / 单位:mm

Tolerance / 公差:±0.5

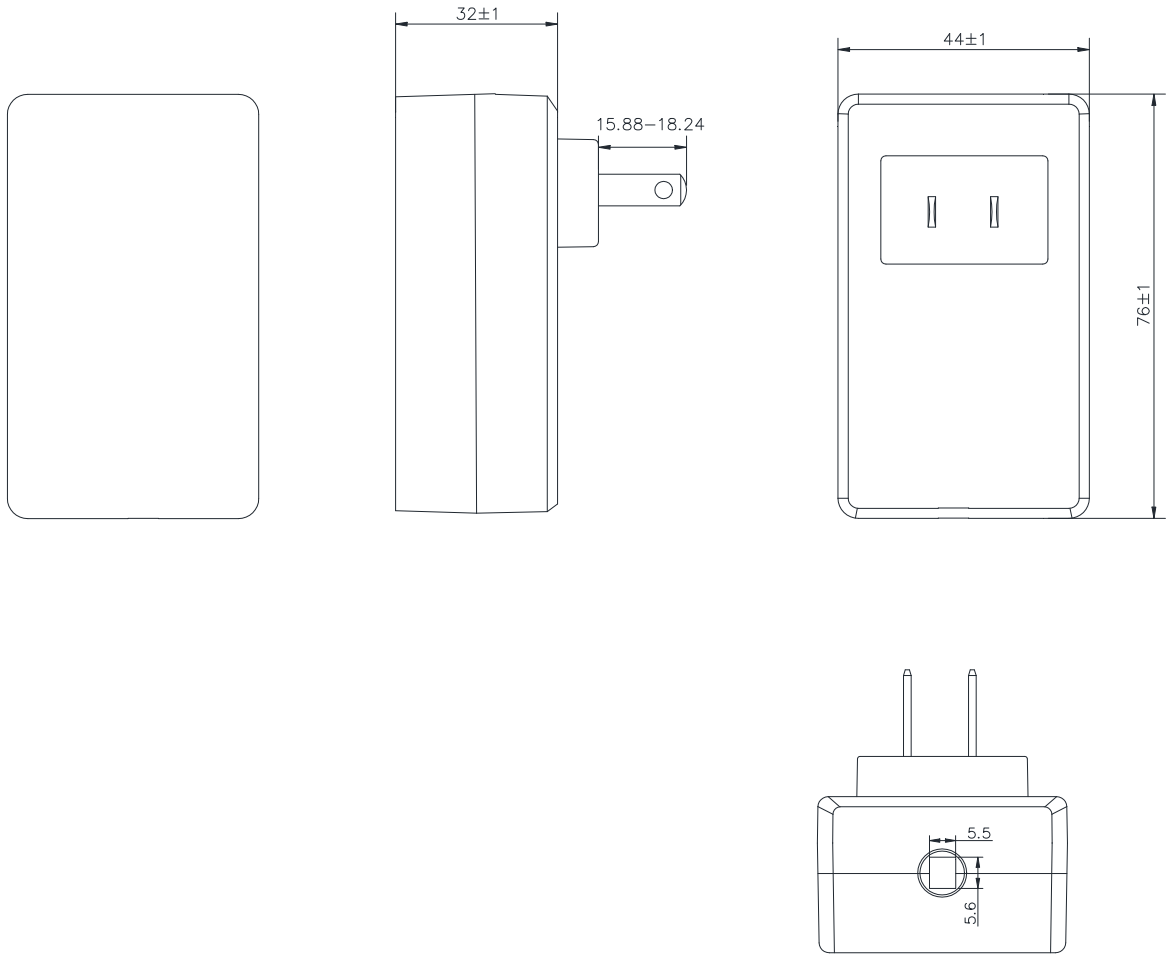

13、重量 / WEIGHT:

电源的重量大约为 112 g

The weight of the power supply shall be about 112 g.

14、结构参数 / MECHANICAL REQUIREMENT:

外型尺寸: L76*W44*H32mm

The power supply size: L76*W44*H32mm.

15、颜色 / COLOUR:

黑色/Black 白色/White

DC CORD / 线材

Unit / 单位:mm

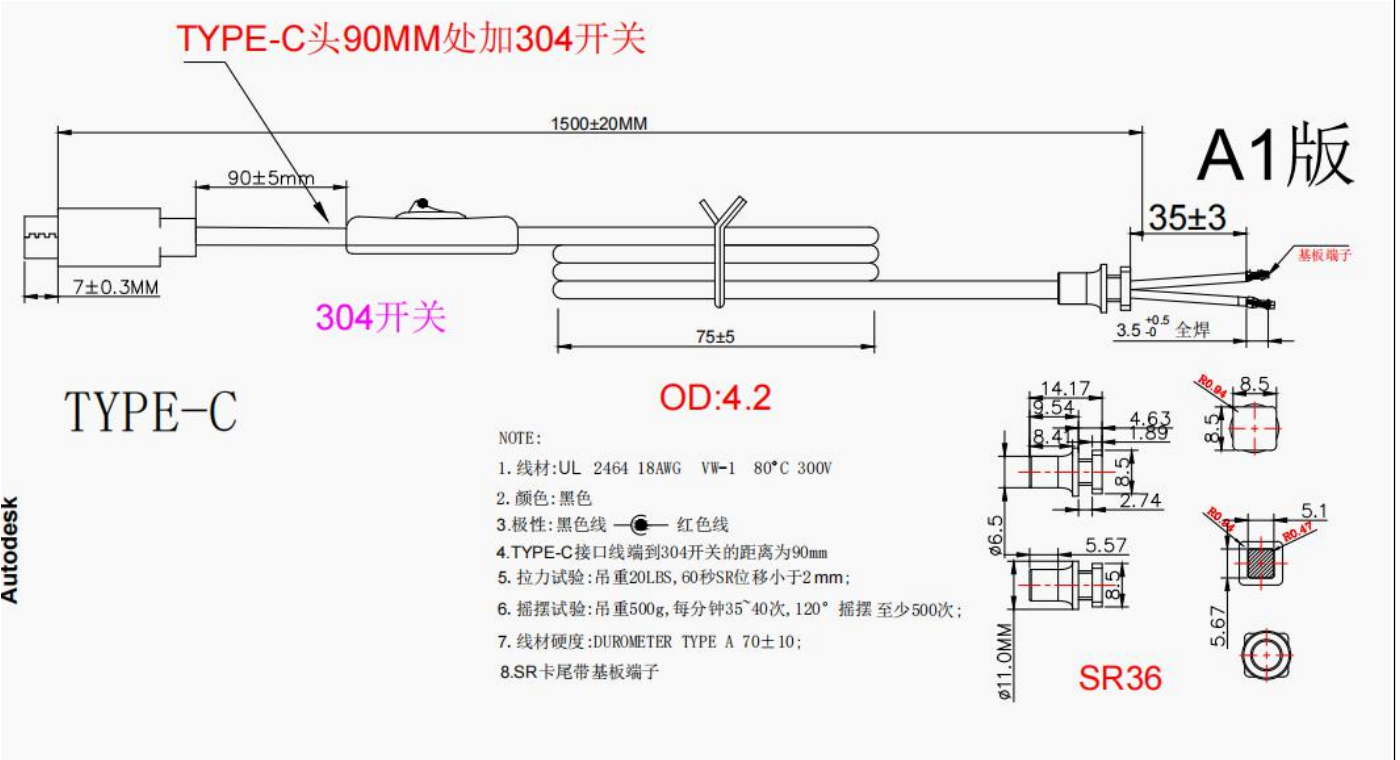





Autodesk

RATING LABEL / 铭牌



Unit / 单位:mm

Tolerance / 公差:+0/-0.2mm

Switching Power Supply  [®]
MODEL:XSG-0504000HUS
INPUT:100-240V~50/60Hz 0.8A Max
OUTPUT:5V $\overline{=}$ 4A

 **UL** [®] **US**  **FC** 

LISTED LPS
E480515

  

I.T.E. POWER SUPPLY
Shenzhen Sunshine Technological Co.,Ltd.
MADE IN CHINA  **YYWW**

激光镭雕



RATING LABEL / 包装图

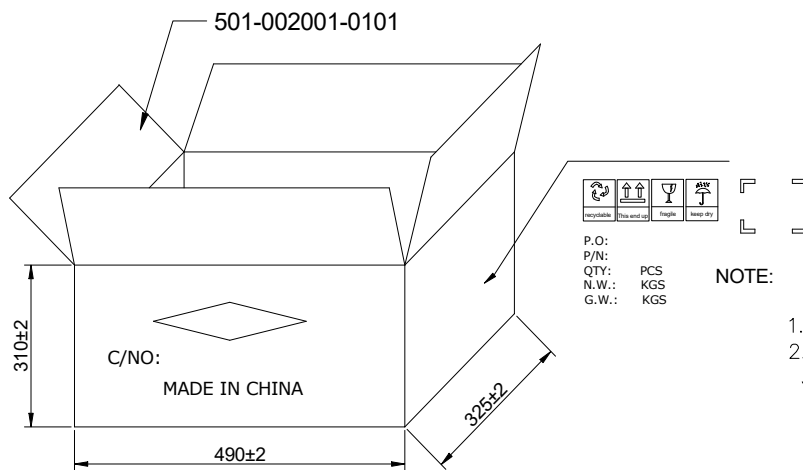
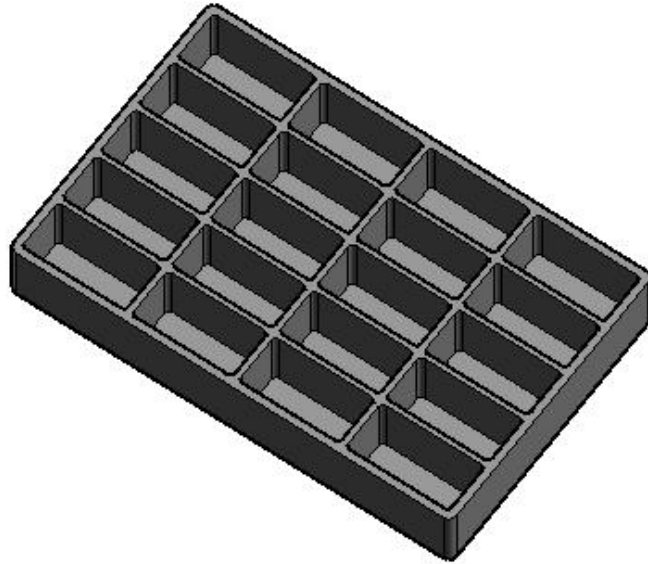

NOTE:

1. PE袋/吸塑包装，每箱包装80台。
2. PK箱标示尺寸为外部尺寸
3. PK箱印前後相同，左右相同，印刷颜色为黑色