Stand-Alone System Load Sharing and Li-Ion / Li-Polymer Battery Charge Management Controller

Features

- Integrated System Load Sharing and Battery Charge Management
 - Simultaneously Power the System and Charge the Li-Ion Battery
 - Voltage Proportional Current Control (VPCC) ensures system load has priority over Li-Ion battery charge current
 - Low-Loss Power-Path Management with Ideal Diode Operation
- Complete Linear Charge Management Controller
 - Integrated Pass Transistors
 - Integrated Current Sense
 - Integrated Reverse Discharge Protection
 - Selectable Input Power Sources: USB Port or AC-DC Wall Adapter
- Preset High Accuracy Charge Voltage Options:
 - 4.10V, 4.20V, 4.35V or 4.40V
 - $\pm 0.5\%$ Regulation Tolerance
- Constant Current / Constant Voltage (CC/CV) Operation with Thermal Regulation
- Maximum 1.8A Total Input Current Control
- Resistor Programmable Fast Charge Current Control: 50 mA to 1A
- Resistor Programmable Termination Set Point
- Selectable USB Input Current Control
 - Absolute Maximum: 100 mA (L) / 500 mA (H)
- Automatic Recharge
- Automatic End-of-Charge Control
- Safety Timer With Timer Enable/Disable Control
- 0.1C Preconditioning for Deeply Depleted Cells
- Battery Cell Temperature Monitor
- Undervoltage Lockout (UVLO)
- Low Battery Status Indicator ($\overline{\text{LBO}}$)
- Power-Good Status Indicator ($\overline{\text{PG}}$)
- Charge Status and Fault Condition Indicators
- Numerous Selectable Options Available for a Variety of Applications:
 - Refer to **Section 1.0 “Electrical Characteristics”** for Selectable Options”
 - Refer to the **“Product Identification System”** for Standard Options
- Temperature Range: -40°C to +85°C
- Packaging: 20-Lead QFN (4 mm x 4 mm)

Applications

- GPSs / Navigators
- PDAs and Smart Phones
- Portable Media Players and MP3 Players
- Digital Cameras
- Bluetooth Headsets
- Portable Medical Devices
- Charge Cradles / Docking Stations
- Toys

Description

The MCP73871 device is a fully integrated linear solution for system load sharing and Li-Ion / Li-Polymer battery charge management with ac-dc wall adapter and USB port power sources selection. It's also capable of autonomous power source selection between input or battery. Along with its small physical size, the low number of required external components makes the device ideally suited for portable applications.

The MCP73871 device automatically obtains power for the system load from a single-cell Li-Ion battery or an input power source (ac-dc wall adapter or USB port). The MCP73871 device specifically adheres to the current drawn limits governed by the USB specification. With an ac-dc wall adapter providing power to the system, an external resistor sets the magnitude of 1A maximum charge current while supports up to 1.8A total current for system load and battery charge current.

The MCP73871 device employs a constant current / constant voltage (CC/CV) charge algorithm with selectable charge termination point. The constant voltage regulation is fixed with four available options: 4.10V, 4.20V, 4.35V, or 4.40V to accommodate new, emerging battery charging requirements. The MCP73871 device also limits the charge current based on die temperature during high power or high ambient conditions. This thermal regulation optimizes the charge cycle time while maintaining device reliability.

The MCP73871 device includes a low battery indicator, a power-good indicator and two charge status indicators that allows for outputs with LEDs or communication with host microcontrollers. The MCP73871 device is fully specified over the ambient temperature range of -40°C to +85°C.

Functional Block Diagram

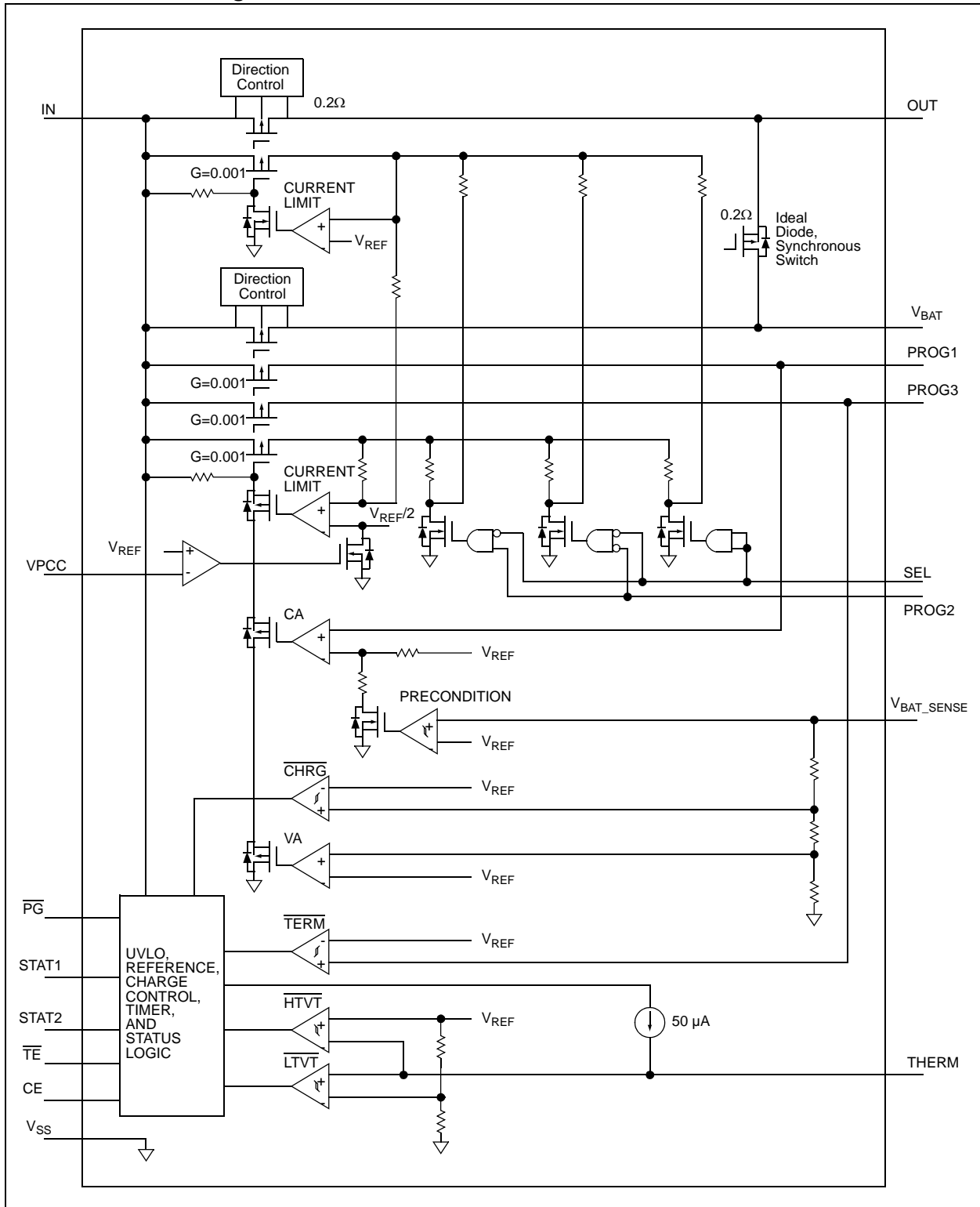

MCP73871

NOTES:

1.0 ELECTRICAL CHARACTERISTICS

Absolute Maximum Ratings†

V_{IN} 7.0V
 All Inputs and Outputs w.r.t. $V_{SS}-0.3V$ to $V_{DD}+0.3V$
 ($V_{DD} = V_{IN}$ or V_{BAT})
 Maximum Junction Temperature, T_J Internally Limited
 Storage temperature $-65^{\circ}C$ to $+150^{\circ}C$
 ESD protection on all pins
 Human Body Model (1.5 k Ω in Series with 100pF) ≥ 4 kV
 Machine Model (200 pF, No Series Resistance) 300V

† **Notice:** Stresses above those listed under “Maximum Ratings” may cause permanent damage to the device. This is a stress rating only and functional operation of the device at those or any other conditions above those indicated in the operational listings of this specification is not implied. Exposure to maximum rating conditions for extended periods may affect device reliability.

DC CHARACTERISTICS

Electrical Specifications: Unless otherwise indicated, all limits apply for $V_{IN} = V_{REG} + 0.3V$ to 6V, $T_A = -40^{\circ}C$ to $+85^{\circ}C$. Typical values are at $+25^{\circ}C$, $V_{IN} = [V_{REG}(\text{typical}) + 1.0V]$

Parameters	Sym	Min	Typ	Max	Units	Conditions
Supply Input						
Supply Voltage	V_{IN}	$V_{REG} + 0.3V$	—	6	V	
Supply Current	I_{SS}	—	2500	3750	μA	Charging
		—	260	350	μA	Charge Complete
		—	180	300	μA	Standby
		—	28	50	μA	Shutdown ($V_{DD} \leq V_{BAT} - 100$ mV or $V_{DD} < V_{STOP}$)
UVLO Start Threshold	V_{START}	$V_{REG} + 0.05V$	$V_{REG} + 0.15V$	$V_{REG} + 0.25V$	V	$V_{DD} = \text{Low-to-High}$
UVLO Stop Threshold	V_{STOP}	$V_{REG} - 0.07V$	$V_{REG} + 0.07V$	$V_{REG} + 0.17V$	V	$V_{DD} = \text{High-to-Low}$
UVLO Hysteresis	V_{HYS}	—	90	—	mV	
Voltage Regulation (Constant Voltage Mode)						
Regulated Charge Voltage	V_{REG}	4.080	4.10	4.121	V	$V_{DD} = [V_{REG}(\text{typical}) + 1V]$ $I_{OUT} = 10$ mA $T_A = -5^{\circ}C$ to $+55^{\circ}C$
		4.179	4.20	4.221	V	
		4.328	4.35	4.372	V	
		4.378	4.40	4.422	V	
Regulated Charge Voltage Tolerance	V_{RTOL}	-0.5	—	+0.5	%	$T_A = +25^{\circ}C$
		-0.75	—	+0.75	%	$T_A = -5^{\circ}C$ to $+55^{\circ}C$
Line Regulation	$ \frac{\Delta V_{BAT}/V_{BAT}}{\Delta V_{DD}} $	—	0.08	0.20	%/V	$V_{DD} = [V_{REG}(\text{typical}) + 1V]$ to 6V $I_{OUT} = 10$ mA
Load Regulation	$ \Delta V_{BAT}/V_{BAT} $	—	0.08	0.18	%	$I_{OUT} = 10$ mA to 150 mA $V_{DD} = [V_{REG}(\text{typical}) + 1V]$
Supply Ripple Attenuation	PSRR	—	-47	—	dB	$I_{OUT} = 10$ mA, 1 kHz
		—	-40	—	dB	$I_{OUT} = 10$ mA, 10 kHz
Current Regulation (Fast Charge Constant-Current Mode)						
AC-Adapter Fast Charge Current	I_{REG}	90	100	110	mA	PROG1 = 10 k Ω
		900	1000	1100	mA	PROG1 = 1 k Ω , $T_A = -5^{\circ}C$ to $+55^{\circ}C$, SEL = Hi
USB Fast Charge Current	I_{REG}	80	90	100	mA	PROG2 = Low, SEL = Low, (Note 2)
		400	450	500	mA	PROG2 = High, SEL = Low, (Note 2) $T_A = -5^{\circ}C$ to $+55^{\circ}C$

Note 1: The value is ensured by design and not production tested.

Note 2: The maximum available charge current is also limited by the value set at PROG1 input.

MCP73871

DC CHARACTERISTICS (CONTINUED)

Electrical Specifications: Unless otherwise indicated, all limits apply for $V_{IN} = V_{REG} + 0.3V$ to 6V, $T_A = -40^{\circ}C$ to $+85^{\circ}C$. Typical values are at $+25^{\circ}C$, $V_{IN} = [V_{REG} \text{ (typical)} + 1.0V]$						
Parameters	Sym	Min	Typ	Max	Units	Conditions
Input Current Limit Control (ICLC)						
USB-Port Supply Current Limit	I_{LIMIT_USB}	80	90	100	mA	PROG2 = Low, SEL = Low PROG2 = High, SEL = Low $T_A = -5^{\circ}C$ to $+55^{\circ}C$
		400	450	500	mA	
AC-DC Adapter Current Limit	I_{LIMIT_AC}	1500	1650	1800	mA	SEL = High, $T_A = -5^{\circ}C$ to $+55^{\circ}C$
Voltage Proportional Charge Control (VPCC - Input Voltage Regulation)						
VPCC Input Threshold	V_{VPCC}	—	1.23	—	V	$I_{OUT} = 10$ mA
VPCC Input Threshold Tolerance	V_{RTOL}	-3	—	+3	%	$T_A = -5^{\circ}C$ to $+55^{\circ}C$
Input Leakage Current	I_{LK}	—	0.01	1	μA	$V_{VPCC} = V_{DD}$
Precondition Current Regulation (Trickle Charge Constant-Current Mode)						
Precondition Current Ratio	I_{PREG} / I_{REG}	7.5	10	12.5	%	PROG1 = 1.0 k Ω to 10 k Ω $T_A = -5^{\circ}C$ to $+55^{\circ}C$
Precondition Current Threshold Ratio	V_{PTH} / V_{REG}	69	72	75	%	V_{BAT} Low-to-High
Precondition Hysteresis	V_{PHYS}	—	105	—	mV	V_{BAT} High-to-Low
Automatic Charge Termination Set Point						
Charge Termination Current Ratio	I_{TERM}	75	100	125	mA	PROG3 = 10 k Ω PROG3 = 100 k Ω $T_A = -5^{\circ}C$ to $+55^{\circ}C$
		7.5	10	12.5	mA	
Automatic Recharge						
Recharge Voltage Threshold Ratio	V_{RTH}	$V_{REG} - 0.21V$	$V_{REG} - 0.15V$	$V_{REG} - 0.09V$	V	V_{BAT} High-to-Low
IN-to-OUT Pass Transistor ON-Resistance						
ON-Resistance	R_{DS_ON}	—	200	—	m Ω	$V_{DD} = 4.5V$, $T_J = 105^{\circ}C$
Charge Transistor ON-Resistance						
ON-Resistance	R_{DSON}	—	200	—	m Ω	$V_{DD} = 4.5V$, $T_J = 105^{\circ}C$
BAT-to-OUT Pass Transistor ON-Resistance						
ON-Resistance	R_{DS_ON}	—	200	—	m Ω	$V_{DD} = 4.5V$, $T_J = 105^{\circ}C$
Battery Discharge Current						
Output Reverse Leakage Current	$I_{DISCHARGE}$	—	30	40	μA	Shutdown ($V_{BAT} < V_{DD} < V_{UVLO}$)
		—	30	40	μA	Shutdown ($0 < V_{DD} \leq V_{BAT}$)
		—	30	40	μA	V_{BAT} = Power Out, No Load
		—	-6	-13	μA	Charge Complete
Status Indicators - STAT1 (LBO), STAT2, PG						
Sink Current	I_{SINK}	—	16	35	mA	
Low Output Voltage	V_{OL}	—	0.4	1	V	$I_{SINK} = 4$ mA
Input Leakage Current	I_{LK}	—	0.01	1	μA	High Impedance, V_{DD} on pin
Low Battery Indicator (LBO)						
Low Battery Detection Threshold	V_{LBO}	—	Disable	—		$V_{BAT} > V_{IN}$, $\overline{PG} = Hi-Z$ $T_A = -5^{\circ}C$ to $+55^{\circ}C$
		2.85	3.0	3.15	V	
		2.95	3.1	3.25	V	
		3.05	3.2	3.35	V	
Low Battery Detection Hysteresis	V_{LBO_HYS}	—	150	—	mV	V_{BAT} Low-to-High

Note 1: The value is ensured by design and not production tested.

Note 2: The maximum available charge current is also limited by the value set at PROG1 input.

DC CHARACTERISTICS (CONTINUED)

Electrical Specifications: Unless otherwise indicated, all limits apply for $V_{IN} = V_{REG} + 0.3V$ to $6V$, $T_A = -40^{\circ}C$ to $+85^{\circ}C$. Typical values are at $+25^{\circ}C$, $V_{IN} = [V_{REG} \text{ (typical)} + 1.0V]$						
Parameters	Sym	Min	Typ	Max	Units	Conditions
PROG1 Input (PROG1)						
Charge Impedance Range	R_{PROG}	1	—	20	$k\Omega$	
PROG3 Input (PROG3)						
Termination Impedance Range	R_{PROG}	5	—	100	$k\Omega$	
PROG2 Input (PROG2)						
Input High Voltage Level	V_{IH}	1.8	—	—	V	
Input Low Voltage Level	V_{IL}	—	—	0.8	V	
Input Leakage Current	I_{LK}	—	0.01	1	μA	$V_{PROG2} = V_{DD}$
Timer Enable (TE)						
Input High Voltage Level	V_{IH}	1.8	—	—	V	Note 1
Input Low Voltage Level	V_{IL}	—	—	0.8	V	Note 1
Input Leakage Current	I_{LK}	—	0.01	1	μA	$V_{TE} = V_{DD}$
Chip Enable (CE)						
Input High Voltage Level	V_{IH}	1.8	—	—	V	
Input Low Voltage Level	V_{IL}	—	—	0.8	V	
Input Leakage Current	I_{LK}	—	0.01	1	μA	$V_{CE} = V_{DD}$
Input Source Selection (SEL)						
Input High Voltage Level	V_{IH}	1.8	—	—	V	
Input Low Voltage Level	V_{IL}	—	—	0.8	V	
Input Leakage Current	I_{LK}	—	0.01	1	μA	$V_{SEL} = V_{DD}$
Thermistor Bias						
Thermistor Current Source	I_{THERM}	47	50	53	μA	$2\text{ k}\Omega < R_{THERM} < 50\text{ k}\Omega$
Thermistor Comparator						
Upper Trip Threshold	V_{T1}	1.20	1.24	1.26	V	V_{T1} Low-to-High
Upper Trip Point Hysteresis	V_{T1HYS}	—	-40	—	mV	
Lower Trip Threshold	V_{T2}	0.23	0.25	0.27	V	V_{T2} High-to-Low
Lower Trip Point Hysteresis	V_{T2HYS}	—	40	—	mV	
Thermal Shutdown						
Die Temperature	T_{SD}	—	150	—	$^{\circ}C$	
Die Temperature Hysteresis	T_{SDHYS}	—	10	—	$^{\circ}C$	

Note 1: The value is ensured by design and not production tested.

Note 2: The maximum available charge current is also limited by the value set at PROG1 input.

MCP73871

AC CHARACTERISTICS

Electrical Specifications: Unless otherwise indicated, all limits apply for $V_{IN} = 4.6V$ to $6V$. Typical values are at $+25^{\circ}C$, $V_{DD} = [V_{REG} \text{ (typical)} + 1.0V]$						
Parameters	Sym	Min	Typ	Max	Units	Conditions
UVLO Start Delay	t_{START}	—	—	5	ms	V_{DD} Low-to-High
Current Regulation						
Transition Time Out of Precondition	t_{DELAY}	—	—	10	ms	$V_{BAT} < V_{PTH}$ to $V_{BAT} > V_{PTH}$
Current Rise Time Out of Precondition	t_{RISE}	—	—	10	ms	I_{OUT} Rising to 90% of I_{REG}
Precondition Comparator Filter Time	t_{PRECON}	0.4	1.3	3.2	ms	Average V_{BAT} Rise/Fall
Termination Comparator Filter Time	t_{TERM}	0.4	1.3	3.2	ms	Average I_{OUT} Falling
Charge Comparator Filter Time	t_{CHARGE}	0.4	1.3	3.2	ms	Average V_{BAT} Falling
Thermistor Comparator Filter Time	t_{THERM}	0.4	1.3	3.2	ms	Average THERM Rise/Fall
Elapsed Timer						
Elapsed Timer Period	$t_{ELAPSED}$	—	0	—	Hours	
		3.6	4.0	4.4	Hours	
		5.4	6.0	6.6	Hours	
		7.2	8.0	8.8	Hours	
Status Indicators						
Status Output Turn-off	t_{OFF}	—	—	500	μs	$I_{SINK} = 1 \text{ mA to } 0 \text{ mA}$
Status Output Turn-on	t_{ON}	—	—	500	μs	$I_{SINK} = 0 \text{ mA to } 1 \text{ mA}$

Note 1: Internal safety timer is tested base on internal oscillator frequency measurement.

TEMPERATURE SPECIFICATIONS

Electrical Specifications: Unless otherwise indicated, all limits apply for $V_{IN} = 4.6V$ to $6V$. Typical values are at $+25^{\circ}C$, $V_{DD} = [V_{REG} \text{ (typical)} + 1.0V]$						
Parameters	Sym	Min	Typ	Max	Units	Conditions
Temperature Ranges						
Specified Temperature Range	T_A	-40	—	+85	$^{\circ}C$	
Operating Temperature Range	T_J	-40	—	+125	$^{\circ}C$	
Storage Temperature Range	T_A	-65	—	+150	$^{\circ}C$	
Thermal Package Resistances						
Thermal Resistance, 20LD-QFN, 4x4	θ_{JA}	—	35	—	$^{\circ}C/W$	4-Layer JC51-7 Standard Board, Natural Convection

2.0 TYPICAL PERFORMANCE CURVES

Note: The graphs and tables provided following this note are a statistical summary based on a limited number of samples and are provided for informational purposes only. The performance characteristics listed herein are not tested or guaranteed. In some graphs or tables, the data presented may be outside the specified operating range (e.g., outside specified power supply range) and therefore outside the warranted range.

Note: Unless otherwise indicated, $V_{IN} = [V_{REG}(\text{typical}) + 1V]$, $I_{OUT} = 10\text{ mA}$ and $T_A = +25^\circ\text{C}$, Constant-voltage mode.

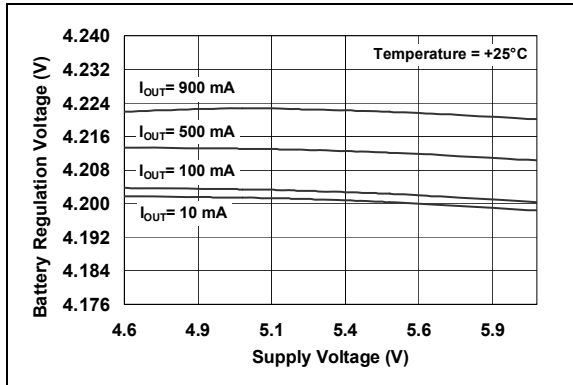

FIGURE 2-1: Battery Regulation Voltage (V_{BAT}) vs. Supply Voltage (V_{DD}).

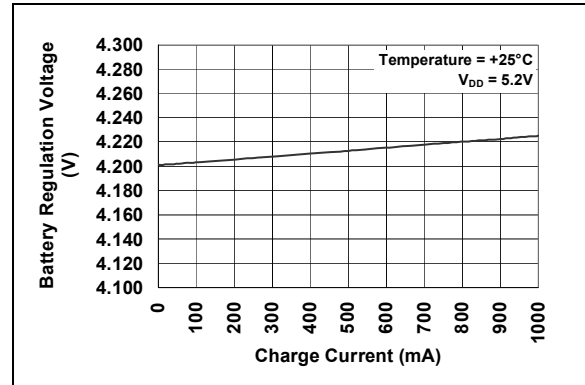

FIGURE 2-4: Charge Current (I_{OUT}) vs. Battery Regulation Voltage (V_{BAT}).

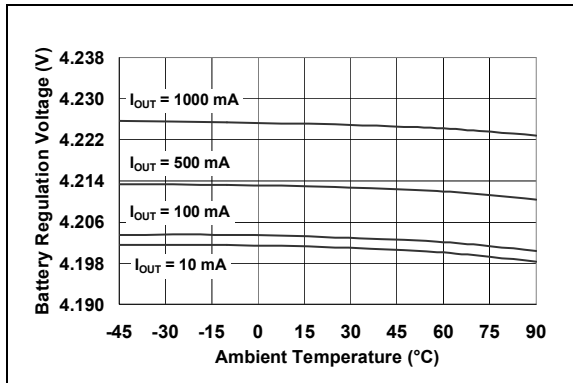

FIGURE 2-2: Battery Regulation Voltage (V_{BAT}) vs. Ambient Temperature (T_A).

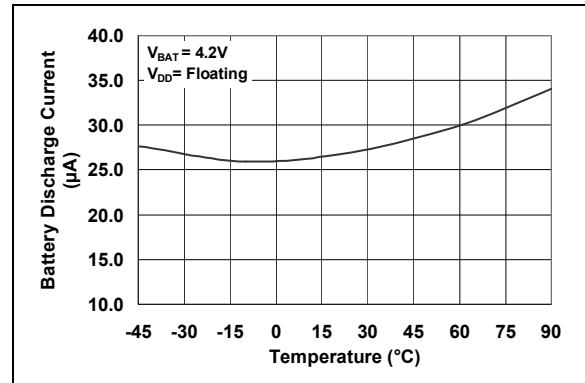

FIGURE 2-5: Output Leakage Current ($I_{DISCHARGE}$) vs. Ambient Temperature (T_A).

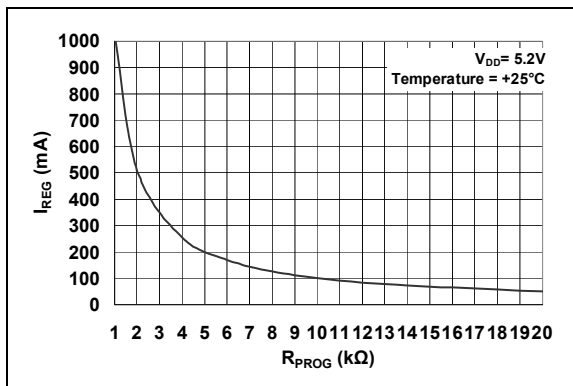

FIGURE 2-3: Charge Current (I_{OUT}) vs. Programming Resistor (R_{PROG}).

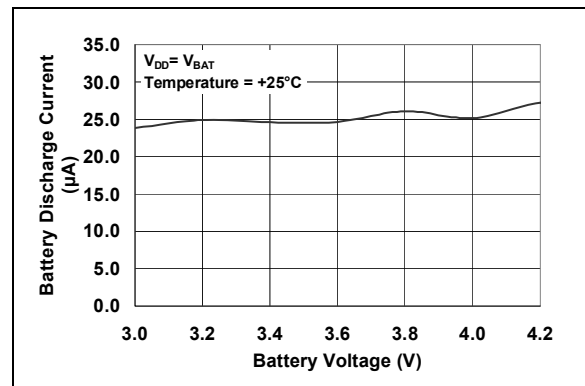

FIGURE 2-6: Output Leakage Current ($I_{DISCHARGE}$) vs. Battery Regulation Voltage (V_{BAT}).

MCP73871

Note: Unless otherwise indicated, $V_{IN} = [V_{REG}(\text{typical}) + 1V]$, $I_{OUT} = 10 \text{ mA}$ and $T_A = +25^\circ\text{C}$, Constant-voltage mode.

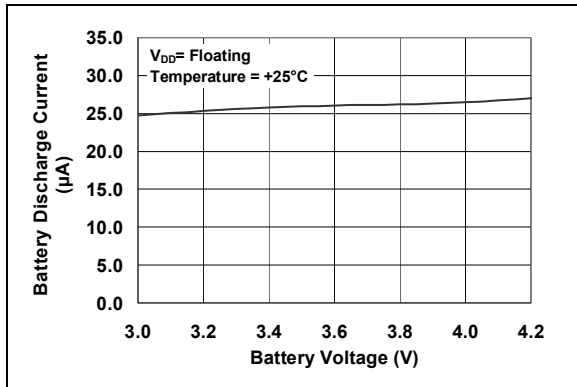

FIGURE 2-7: Output Leakage Current ($I_{DISCHARGE}$) vs. Battery Voltage (V_{BAT}).

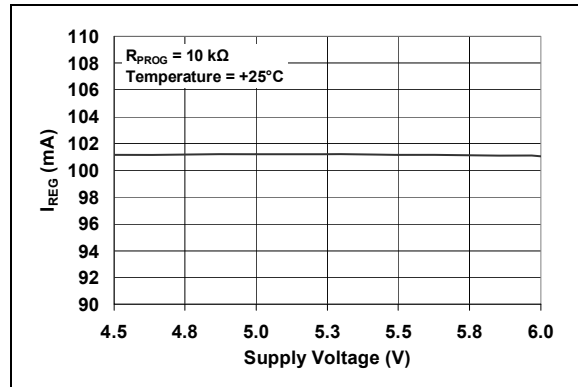

FIGURE 2-10: Charge Current (I_{OUT}) vs. Supply Voltage (V_{DD}).

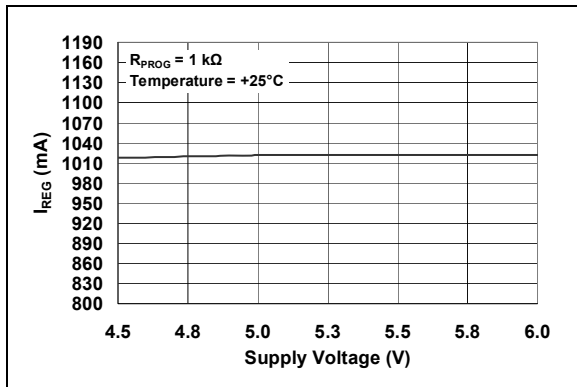

FIGURE 2-8: Charge Current (I_{OUT}) vs. Supply Voltage (V_{DD}).

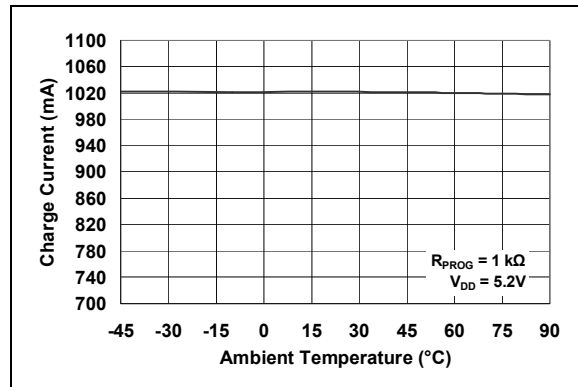

FIGURE 2-11: Charge Current (I_{OUT}) vs. Ambient Temperature (T_A).

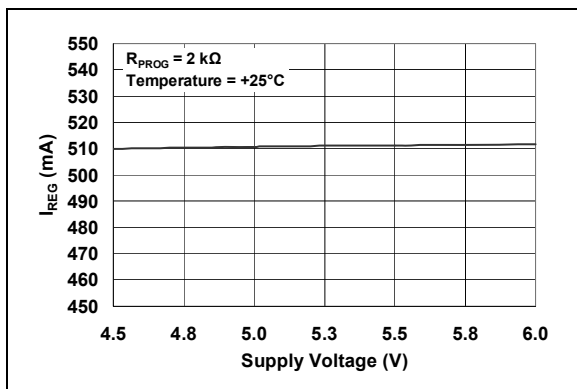

FIGURE 2-9: Charge Current (I_{OUT}) vs. Supply Voltage (V_{DD}).

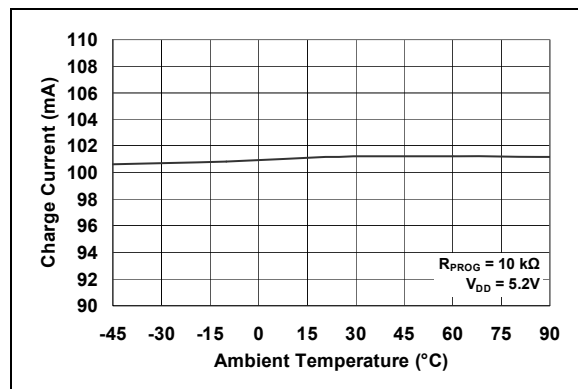

FIGURE 2-12: Charge Current (I_{OUT}) vs. Ambient Temperature (T_A).

Note: Unless otherwise indicated, $V_{IN} = [V_{REG}(\text{typical}) + 1V]$, $I_{OUT} = 10 \text{ mA}$ and $T_A = +25^\circ\text{C}$, Constant-voltage mode.

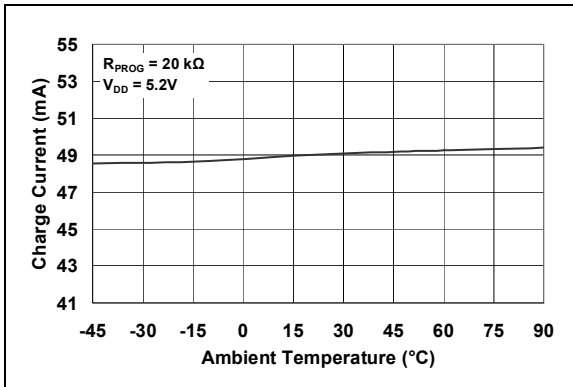

FIGURE 2-13: Charge Current (I_{OUT}) vs. Ambient Temperature (T_A).

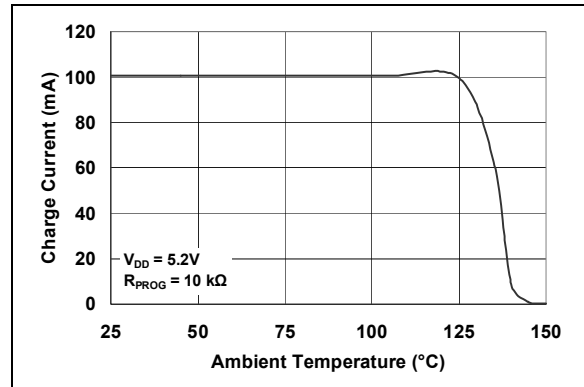

FIGURE 2-16: Charge Current (I_{OUT}) vs. Junction Temperature (T_J).

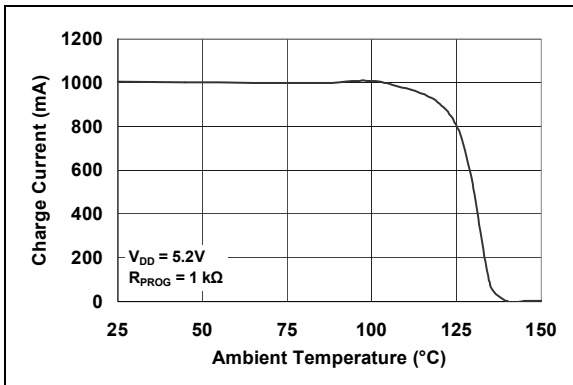

FIGURE 2-14: Charge Current (I_{OUT}) vs. Junction Temperature (T_J).

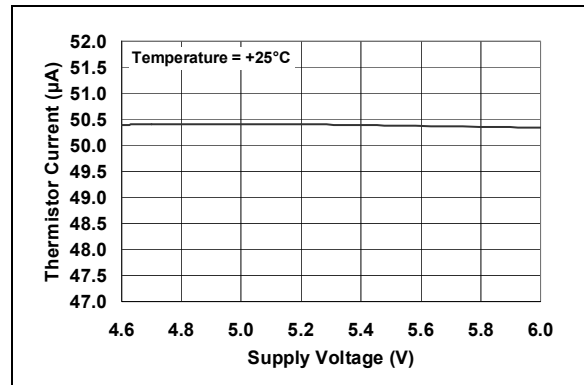

FIGURE 2-17: Thermistor Current (I_{THERM}) vs. Supply Voltage (V_{DD}).

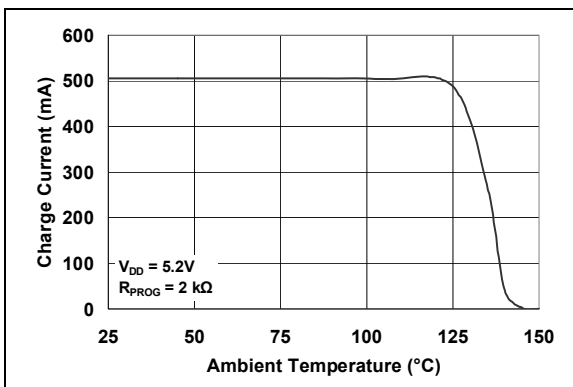

FIGURE 2-15: Charge Current (I_{OUT}) vs. Junction Temperature (T_J).

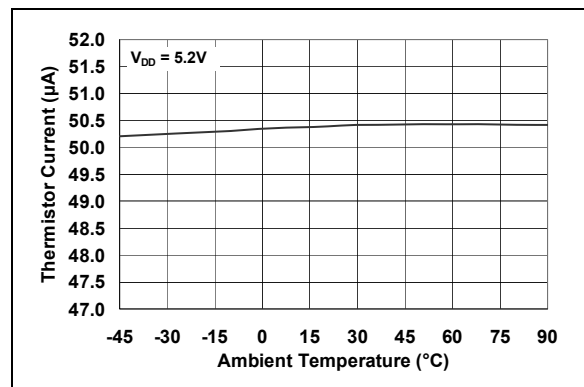

FIGURE 2-18: Thermistor Current (I_{THERM}) vs. Ambient Temperature (T_A).

MCP73871

Note: Unless otherwise indicated, $V_{IN} = [V_{REG}(\text{typical}) + 1V]$, $I_{OUT} = 10 \text{ mA}$ and $T_A = +25^\circ\text{C}$, Constant-voltage mode.

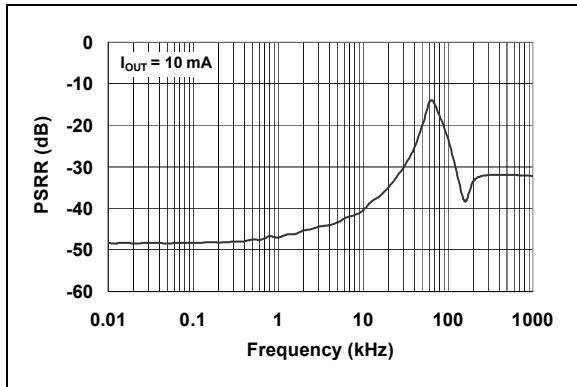

FIGURE 2-19: Power Supply Ripple Rejection (PSRR).

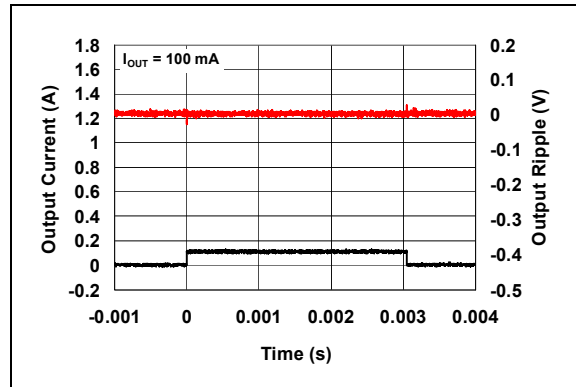

FIGURE 2-22: Load Transient Response. $I_{OUT} = 100 \text{ mA}$.

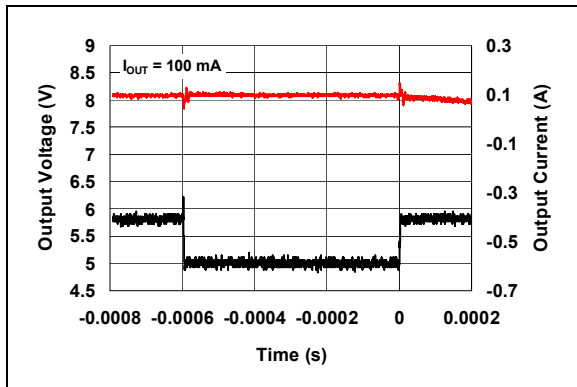

FIGURE 2-20: Line Transient Response. $I_{OUT} = 100 \text{ mA}$.

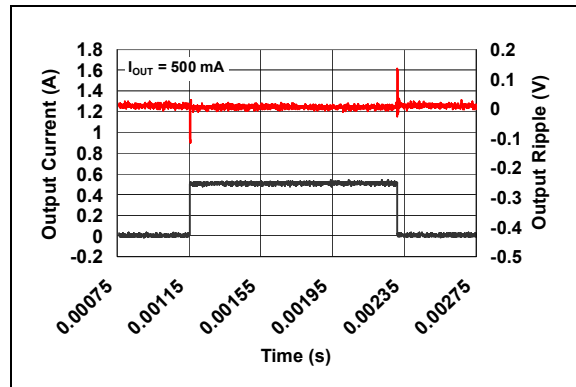

FIGURE 2-23: Load Transient Response. $I_{OUT} = 500 \text{ mA}$.

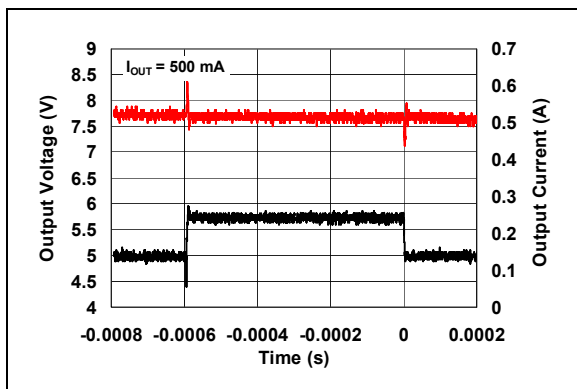

FIGURE 2-21: Line Transient Response. $I_{OUT} = 500 \text{ mA}$.

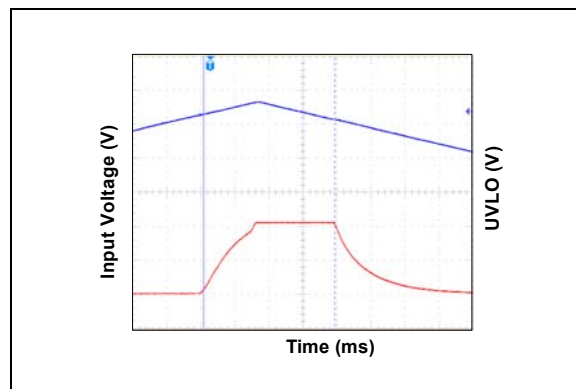

FIGURE 2-24: Undervoltage Lockout.

Note: Unless otherwise indicated, $V_{IN} = [V_{REG}(\text{typical}) + 1V]$, $I_{OUT} = 10 \text{ mA}$ and $T_A = +25^\circ\text{C}$, Constant-voltage mode.

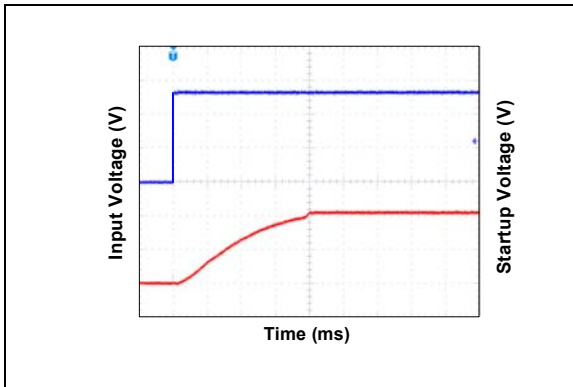

FIGURE 2-25: Startup Delay.

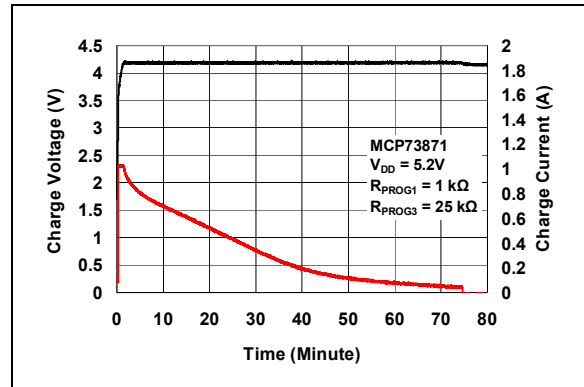

FIGURE 2-27: Complete Charge Cycle (1000 mAh Li-Ion Battery).

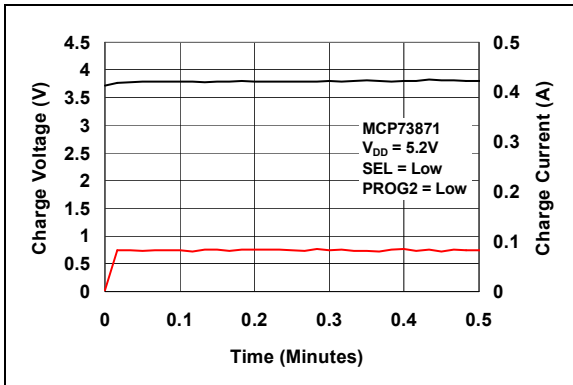

FIGURE 2-26: Complete Charge Cycle (130 mAh Li-Ion Battery).

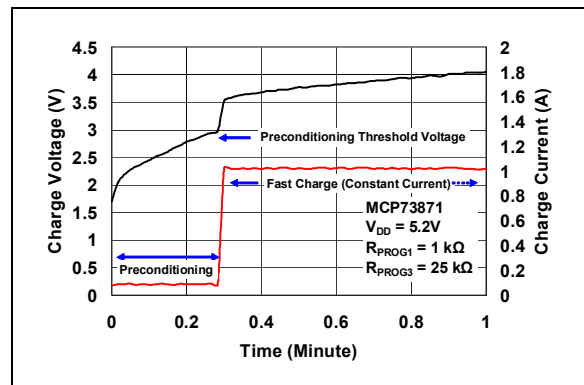

FIGURE 2-28: Typical Charge Profile in Preconditioning (1000 mAh Battery).

MCP73871

NOTES:

3.0 PIN DESCRIPTION

The descriptions of the pins are listed in [Table 3-1](#).

TABLE 3-1: PIN FUNCTION TABLES

Pin Number	Symbol	I/O	Function
1, 20	OUT	O	System Output Terminal
2	VPCC	I	Voltage proportional charge control
3	SEL	I	Input type selection (Low for USB port, High for ac-dc adapter)
4	PROG2	I	USB port input current limit selection when SEL = Low. (Low = 100 mA, High = 500 mA)
5	THERM	I/O	Thermistor monitoring input and bias current
6	$\overline{\text{PG}}$	O	Power-Good Status Output (Open-Drain)
7	STAT2	O	Charge Status Output 2 (Open-Drain)
8	STAT1 / LBO	O	Charge Status Output 1 (Open-Drain). Low battery output indicator when $V_{\text{BAT}} > V_{\text{IN}}$
9	$\overline{\text{TE}}$	I	Timer Enable; Enables Safety Timer when active Low
10, 11, EP	V_{SS}	—	Battery Management 0V Reference. EP (Exposed Thermal Pad); There is an internal electrical connection between the exposed thermal pad and V_{SS} . The EP must be connected to the same potential as the V_{SS} pin on the Printed Circuit Board (PCB)
12	PROG3	I/O	Termination set point for both ac-dc adapter and USB port
13	PROG1	I/O	Fast charge current regulation setting with SEL = High. Preconditioning set point for both USB port and ac-dc adapter.
14, 15	V_{BAT}	I/O	Battery Positive Input and Output connection
16	$V_{\text{BAT_SENSE}}$	I/O	Battery Voltage Sense
17	CE	I	Device Charge Enable; Enabled when CE = High
18, 19	IN	I	Power Supply Input.

Legend: I = Input, O = Output, I/O = Input/Output

Note: The input pins should always tie to either High or Low, and never allow floating to ensure operation properly.

3.1 Power Supply Input (IN)

A supply voltage of $V_{\text{REG}} + 0.3\text{V}$ to 6V is recommended. Bypass to V_{SS} with a minimum of 4.7 μF .

3.2 System Output Terminal (OUT)

The MCP73871 device powers the system via output terminals while independently charging the battery. This feature reduces the charge and discharge cycles on the battery, allows for proper charge termination and the system to run with an absent or defective battery pack. Also, this feature gives the system priority on input power, allowing the system to power-up with deeply depleted battery packs. Bypass to V_{SS} with a minimum of 4.7 μF is recommended.

3.3 Voltage Proportional Charge Control (VPCC)

If the voltage on the IN pin drops to a preset value, determined by the threshold established at the VPCC input, due to a limited amount of input current or input source impedance, the battery charging current is reduced. Further demand from the system is supported by the battery, if possible. To active this feature, simply supply 1.23V or greater to VPCC pin. This feature can be disabled by connecting the VPCC pin to IN.

For example, a system is designed with a 5.5V rated DC power supply with $\pm 0.5\text{V}$ tolerance. The worst condition of 5V is selected, which is used to calculate the VPCC supply voltage with divider.

MCP73871

The voltage divider equation is shown below:

$$V_{VPCC} = \left(\frac{R_2}{R_1 + R_2} \right) \times V_{IN} = 1.23V$$
$$1.23V = \left(\frac{110k\Omega}{110k\Omega + R_1} \right) \times 5V$$
$$R_1 = 337.2k\Omega$$

The calculated R_1 equals to 337.2 k Ω when 110 k Ω is selected for R_2 . The 330 k Ω resistor is selected for R_1 to build the voltage divider for VPCC.

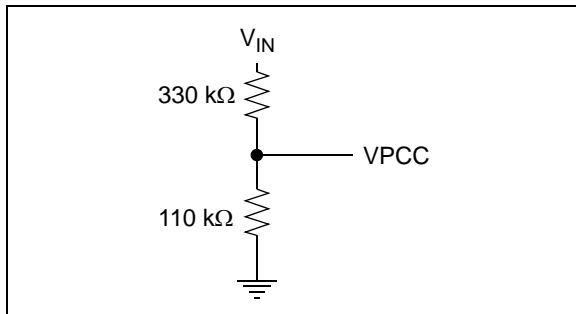

FIGURE 3-1: Voltage Divider Example.

3.4 Input Source Type Selection (SEL)

The input source type selection (SEL) pin is used to select input power source for input current limit control feature. With the SEL input High, the MCP73871 device is designed to provide a typical 1.65A to system power and charge Li-Ion battery from a regular 5V wall adapter. The MCP73871 device limits the input current up to 1.8A. When SEL active Low, the input source is designed to provide system power and Li-Ion battery charging from a USB Port input while adhering to the current limits governed by the USB specification.

3.5 Battery Management 0V Reference (V_{SS})

Connect to negative terminal of battery, system load and input supply.

3.6 Battery Charge Control Output (V_{BAT})

Connect to positive terminal of Li-Ion / Li-Polymer batteries. Bypass to V_{SS} with a minimum of 4.7 μ F to ensure loop stability when the battery is disconnected.

3.7 Battery Voltage Sense (V_{BAT_SENSE})

Connect to positive terminal of battery. A precision internal voltage sense regulates the final voltage on this pin to V_{REG}.

3.8 Charge Current Regulation Set (PROG1)

The maximum constant charge current is set by placing a resistor from PROG1 to V_{SS}. PROG1 sets the maximum constant charge current for both ac-dc adapter and USB port. However, the actual charge current is based on input source type and system load requirement.

3.9 USB-Port Current Regulation Set (PROG2)

The MCP73871 device USB-Port current regulation set input (PROG2) is a digital input selection. A logic Low selects a 1 unit load input current from USB port (100 mA); a logic High selects a 5 unit loads input current from USB port (500 mA).

3.10 Charge Status Output 1 (STAT1)

STAT1 is an open-drain logic output for connection to an LED for charge status indication. Alternatively, a pull-up resistor can be applied for interfacing to a host microcontroller. Refer to Table 5-1 for a summary of the status output during a charge cycle.

3.11 Charge Status Output 2 (STAT2)

STAT2 is an open-drain logic output for connection to an LED for charge status indication. Alternatively, a pull-up resistor can be applied for interfacing to a host microcontroller. Refer to Table 5-1 for a summary of the status output during a charge cycle.

3.12 Power-Good (\overline{PG})

The power-good (\overline{PG}) is an open-drain logic output for input power supply indication. The \overline{PG} output is low whenever the input to the MCP73871 device is above the UVLO threshold and greater than the battery voltage. The \overline{PG} output can be used as an indication to the user via an illuminated LED or to the system via a pull-up resistor for interfacing to a host microcontroller that an input source other than the battery is supplying power. Refer to Table 5-1 for a summary of the status output during a charge cycle.

3.13 Low Battery Output (\overline{LBO})

STAT1 also serves as low battery output (LBO) if the selected MCP73871 is equipped with this feature. It reminds the system or end user when the Li-Ion battery voltage level is low. The \overline{LBO} feature enables when the system is running from the Li-Ion batteries. The \overline{LBO} indicator can be used as an indication to the user via lit up LED or to the system via a pull-up resistor for interfacing to a host microcontroller that an input source other than the battery is supplying power. Refer to Table 5-1 for a summary of the status output during a charge cycle.

3.14 Timer Enable ($\overline{\text{TE}}$)

The timer enable ($\overline{\text{TE}}$) feature is used to enable or disable the internal timer. A low signal on this pin enables the internal timer and a high signal disables the internal timer. The $\overline{\text{TE}}$ input can be used to disable the timer when the system load is substantially limiting the available supply current to charge the battery. The $\overline{\text{TE}}$ input is compatible with 1.8V logic.

Note: The built-in safety timer is available for the following options: 4 HR, 6 HR and 8 HR.

3.15 Battery Temperature Monitor (THERM)

The MCP73871 device continuously monitor battery temperature during a charge cycle by measuring the voltage between the THERM and V_{SS} pins. An internal 50 μA current source provides the bias for most common 10 k Ω negative-temperature coefficient thermistors (NTC). The MCP73871 device compares the voltage at the THERM pin to factory set thresholds of 1.24V and 0.25V, typically. Once a voltage outside the thresholds is detected during a charge cycle, the MCP73871 device immediately suspends the charge cycle. The charge cycle resumes when the voltage at the THERM pin returns to the normal range. The charge temperature window can be set by placing fixed value resistors in series-parallel with a thermistor. Refer to **Section 6.0 “Applications”** for calculations of resistance values.

3.16 Charge Enable (CE)

With the CE input Low, the Li-Ion battery charger feature of the MCP73871 will be disabled. The charger feature is enabled when CE is active High. Allowing the CE pin to float during the charge cycle may cause system instability. The CE input is compatible with 1.8V logic. Refer to **Section 6.0 “Applications”** for various applications in designing with CE features.

3.17 Exposed Thermal Pad (EP)

There is an internal electrical connection between the Exposed Thermal Pad (EP) and the V_{SS} pin; they must be connected to the same potential.

MCP73871

NOTES:

4.0 DEVICE OVERVIEW

The MCP73871 device is a simple, but fully integrated linear charge management controllers with system load sharing feature. Figure 4-1 depicts the operational flow algorithm.

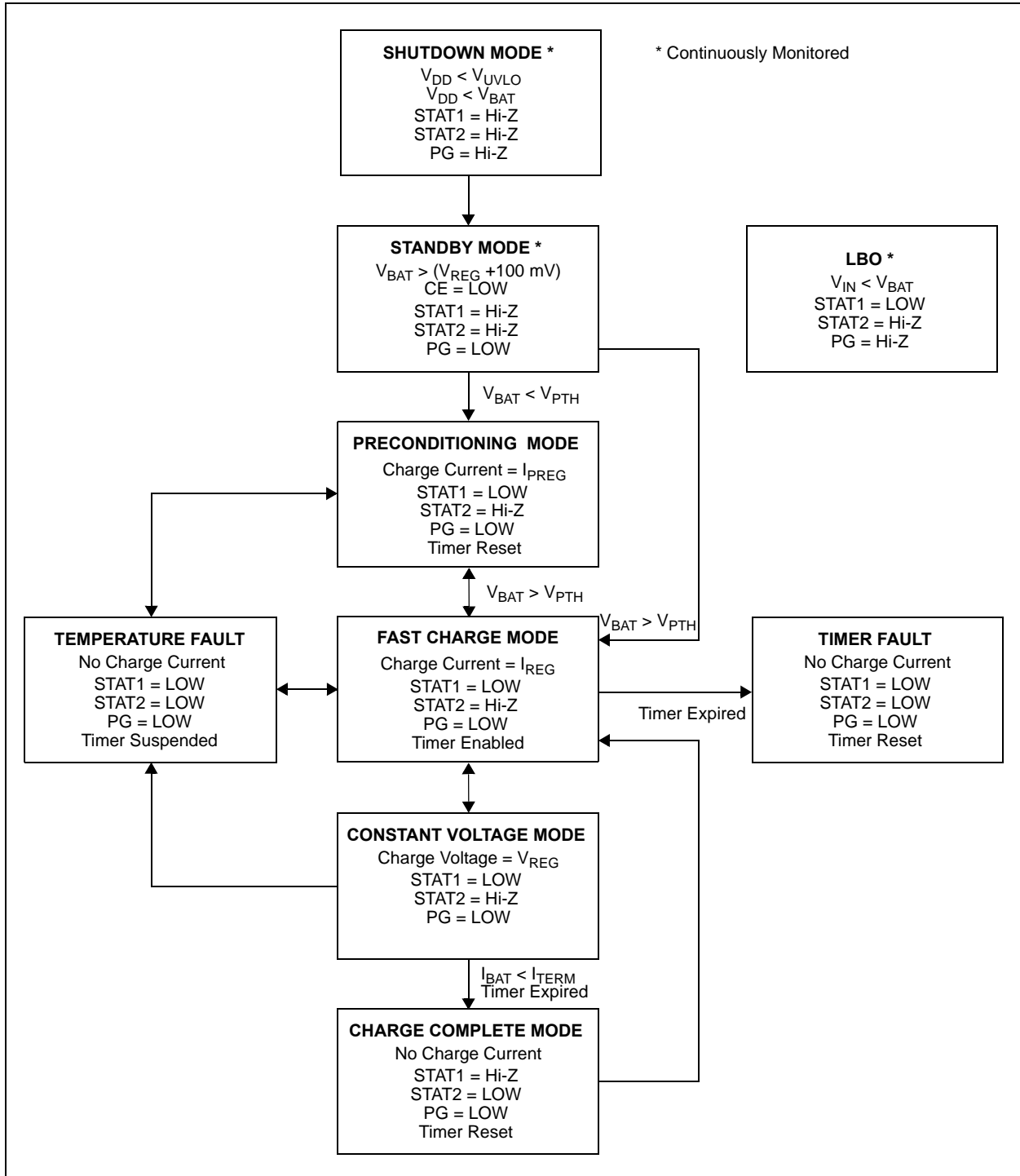

FIGURE 4-1: MCP73871 Device Flow Chart.

MCP73871

4.1 UnderVoltage Lockout (UVLO)

An internal undervoltage lockout (UVLO) circuit monitors the input voltage and keeps the charger in shutdown mode until the input supply rises above the UVLO threshold.

In the event a battery is present when the input power is applied, the input supply must rise approximately 100 mV above the battery voltage before the MCP73871 device become operational.

The UVLO circuit places the device in shutdown mode if the input supply falls to approximately 100 mV of the battery voltage.

The UVLO circuit is always active. At any time, the input supply is below the UVLO threshold or approximately 100 mV of the voltage at the V_{BAT} pin, the MCP73871 device is placed in a shutdown mode.

During any UVLO condition, the battery reverse discharge current shall be less than 2 μ A.

4.2 System Load Sharing

The system load sharing feature gives the system priority on input power, allowing the system to power-up with deeply depleted battery packs.

With the SEL input active Low, the MCP73871 device is designed to provide system power and Li-Ion battery charging from a USB input while adhering to the current limits governed by the USB specification.

With the SEL input active High, the MCP73871 device limits the total supply current to 1.8A (system power and charge current combined).

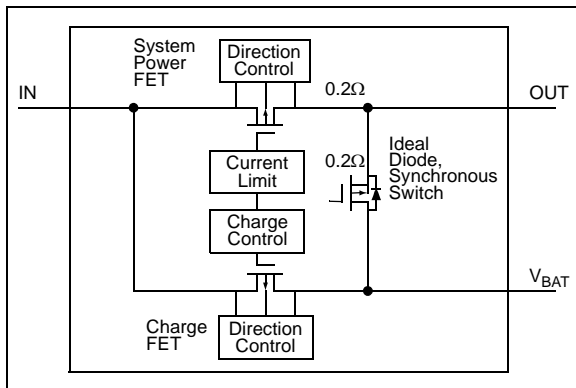

FIGURE 4-2: System Load Sharing Diagram.

4.3 Charge Qualification

For a charge cycle to begin, all UVLO conditions must be met and a battery or output load must be present.

A charge current programming resistor must be connected from PROG1 to V_{SS} when SEL = High. When SEL = Low, PROG2 needs to tie to High or Low for proper operation.

4.4 Preconditioning

If the voltage at the V_{BAT} pin is less than the preconditioning threshold, the MCP73871 device enters a preconditioning mode. The preconditioning threshold is factory set. Refer to **Section 1.0 “Electrical Characteristics”** for preconditioning threshold options.

In this mode, the MCP73871 device supplies 10% of the fast charge current (established with the value of the resistor connected to the PROG1 pin) to the battery.

When the voltage at the V_{BAT} pin rises above the preconditioning threshold, the MCP73871 device enters the constant current (fast charge) mode.

4.5 Constant Current Mode - Fast Charge

During the constant current mode, the programmed charge current is supplied to the battery or load. The charge current is established using a single resistor from PROG1 to V_{SS} . The program resistor and the charge current are calculated using the following equation:

EQUATION 4-1:

$$I_{REG} = \frac{1000V}{R_{PROG1}}$$

Where:

R_{PROG}	=	kilo-ohms (k Ω)
I_{REG}	=	milliampere (mA)

Constant current mode is maintained until the voltage at the V_{BAT} pin reaches the regulation voltage, V_{REG} .

When constant current mode is invoked, the internal timer is reset.

4.5.1 TIMER EXPIRED DURING CONSTANT CURRENT - FAST CHARGE MODE

If the internal timer expires before the recharge voltage threshold is reached, a timer fault is indicated and the charge cycle terminates. The MCP73871 device remains in this condition until the battery is removed. If the battery is removed, the MCP73871 device enters the Stand-by mode where it remains until a battery is reinserted.

4.6 Constant Voltage Mode

When the voltage at the V_{BAT} pin reaches the regulation voltage, V_{REG} , constant voltage regulation begins. The regulation voltage is factory set to 4.10V or 4.20V with a tolerance of $\pm 0.5\%$.

4.7 Charge Termination

The charge cycle is terminated when, during constant voltage mode, the average charge current diminishes below a threshold established with the value of a resistor connected from PROG3 to V_{SS} or internal timer has expired. A 1 ms filter time on the termination comparator ensures that transient load conditions do not result in premature charge cycle termination. The timer period is factory set and can be disabled. Refer to **Section 1.0 “Electrical Characteristics”** for timer period options.

The program resistor and the charge current are calculated using the following equation:

EQUATION 4-2:

$$I_{TERMINATION} = \frac{1000V}{R_{PROG3}}$$

Where:

R_{PROG} = kilo-ohms ($k\Omega$)

I_{REG} = milliamperes (mA)

The charge current is latched off and the MCP73871 device enters a charge complete mode. The recommended PROG3 resistor values are between 5 $k\Omega$ and 100 $k\Omega$.

4.8 Automatic Recharge

The MCP73871 device continuously monitors the voltage at the V_{BAT} pin in the charge complete mode. If the voltage drops below the recharge threshold, another charge cycle begins and current is once again supplied to the battery or load. The recharge threshold is factory set. Refer to **Section 1.0 “Electrical Characteristics”** for recharge threshold options.

Note: Charge termination and automatic recharge features avoid constant charging Li-Ion batteries to prolong life of Li-Ion batteries while keeping their capacity at healthy level.

4.9 Thermal Regulation

The MCP73871 device limits the charge current based on the die temperature. The thermal regulation optimizes the charge cycle time while maintaining device reliability. **Figure 4-3** depicts the thermal regulation for the MCP73871 device. Refer to **Section 1.0 “Electrical Characteristics”** for thermal package resistances and **Section 6.1.1.2 “Thermal Considerations”** for calculating power dissipation.

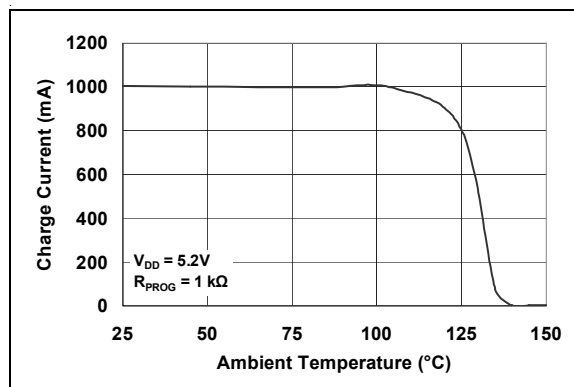

FIGURE 4-3: Thermal Regulation

4.10 Thermal Shutdown

The MCP73871 device suspends charge if the die temperature exceeds 150°C. Charging will resume when the die temperature has cooled by approximately 10°C. The thermal shutdown is a secondary safety feature in the event that there is a failure within the thermal regulation circuitry.

4.11 Temperature Qualification

The MCP73871 device continuously monitor battery temperature during a charge cycle by measuring the voltage between the THERM and V_{SS} pins. An internal 50 μA current source provides the bias for most common 10 $k\Omega$ negative-temperature coefficient thermistors (NTC). The MCP73871 device compares the voltage at the THERM pin to factory set thresholds of 1.24V and 0.25V, typically. Once a voltage outside the thresholds is detected during a charge cycle, the MCP73871 device immediately suspends the charge cycle. The MCP73871 device suspends charge by turning off the charge pass transistor and holding the timer value. The charge cycle resumes when the voltage at the THERM pin returns to the normal range.

MCP73871

4.12 Voltage Proportional Charge Control (VPCC)

If the voltage on the IN pin drops to a preset value, determined by the threshold established at the VPCC input, due to a limited amount of input current or input source impedance, then the battery charging current is reduced. The VPCC control tries to reach a steady-state condition where the system load has priority and the battery is charged with the remaining current. Therefore, if the system demands more current than the input can provide, the ideal diode will become forward biased and the battery is able to supplement the input current to the system load.

The VPCC sustains the system load as its highest priority. It does this by reducing the noncritical charge current while maintaining the maximum power output of the adapter. Further demand from the system is supported by the battery, if possible.

The VPCC feature functions identically for USB port or ac-dc adapter inputs. This feature can be disabled by connecting the VPCC to IN pin.

4.13 Input Current Limit Control (ICLC)

If the input current threshold is reached, then the battery charging current is reduced. The ICLC tries to reach a steady-state condition where the system load has priority and the battery is charged with the remaining current. No active control limits the current to the system. Therefore, if the system demands more current than the input can provide or the input ICLC is reached, the ideal diode will become forward biased and the battery is able to supplement the input current to the system load.

The ICLC sustains the system load as its highest priority. This is done by reducing the non-critical charge current while adhering to the current limits governed by the USB specification or the maximum ac-dc adapter current supported. Further demand from the system is supported by the battery, if possible.

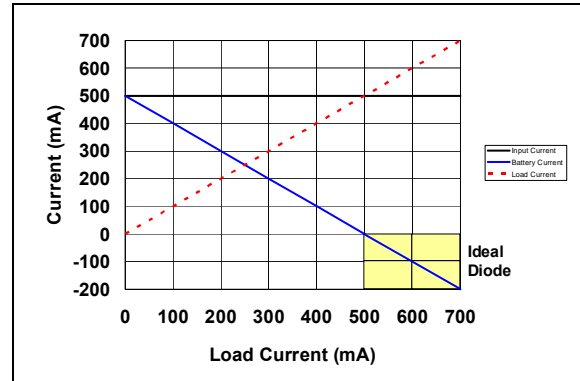

FIGURE 4-4: *Input Current Limit Control - USB Port.*

5.0 DETAILED DESCRIPTION

5.1 Analog Circuitry

5.1.1 LOAD SHARING AND LI-ION BATTERY MANAGEMENT INPUT SUPPLY (V_{IN})

The V_{IN} input is the input supply to the MCP73871 device. The MCP73871 device can be supplied by either AC Adapter (V_{AC}) or USB Port (V_{USB}) with SEL pin. The MCP73871 device automatically powers the system with the Li-Ion battery when the V_{IN} input is not present.

5.1.2 FAST CHARGE CURRENT REGULATION SET (PROG1)

For the MCP73871 device, the charge current regulation can be scaled by placing a programming resistor (R_{PROG1}) from the PROG1 pin to V_{SS}. The program resistor and the charge current are calculated using the following equation:

EQUATION 5-1:

$$I_{REG} = \frac{1000V}{R_{PROG1}}$$

Where:

R_{PROG} = kilo-ohms (kΩ)
 I_{REG} = milliamperes (mA)

The fast charge current is set for maximum charge current from ac-dc adapter and USB port. The preconditioning current is 10% (0.1C) to the fast charge current.

5.1.3 BATTERY CHARGE CONTROL OUTPUT (V_{BAT})

The battery charge control output is the drain terminal of an internal P-channel MOSFET. The MCP73871 device provides constant current and voltage regulation to the battery pack by controlling this MOSFET in the linear region. The battery charge control output should be connected to the positive terminal of the battery pack.

5.1.4 TEMPERATURE QUALIFICATION (THERM)

The MCP73871 device continuously monitors battery temperature during a charge cycle by measuring the voltage between the THERM and V_{SS} pins. An internal 50 μA current source provides the bias for most common 10 kΩ negative-temperature coefficient (NTC) or positive-temperature coefficient (PTC) thermistors. The current source is controlled, avoiding measurement sensitivity to fluctuations in the supply voltage (V_{DD}). The MCP73871 device compares the voltage at the THERM pin to factory set thresholds of

1.24V and 0.25V, typically. Once a voltage outside the thresholds is detected during a charge cycle, the MCP73871 device immediately suspends the charge cycle.

The MCP73871 device suspends charge by turning off the pass transistor and holding the timer value. The charge cycle resumes when the voltage at the THERM pin returns to the normal range.

If temperature monitoring is not required, place a standard 10 kΩ resistor from THERM to V_{SS}.

5.2 Digital Circuitry

5.2.1 STATUS INDICATORS AND POWER-GOOD (PG)

The charge status outputs have two different states: Low (L), and High Impedance (Hi-Z). The charge status outputs can be used to illuminate LEDs. Optionally, the charge status outputs can be used as an interface to a host microcontroller. Table 5-1 summarizes the state of the status outputs during a charge cycle.

TABLE 5-1: STATUS OUTPUTS

CHARGE CYCLE STATE	STAT1	STAT2	$\overline{\text{PG}}$
Shutdown (V _{DD} = V _{BAT})	Hi-Z	Hi-Z	Hi-Z
Shutdown (V _{DD} = IN)	Hi-Z	Hi-Z	L
Preconditioning	L	Hi-Z	L
Constant Current	L	Hi-Z	L
Constant Voltage	L	Hi-Z	L
Charge Complete - Standby	Hi-Z	L	L
Temperature Fault	L	L	L
Timer Fault	L	L	L
Low Battery Output	L	Hi-Z	Hi-Z
No Battery Present	Hi-Z	Hi-Z	L
No Input Power Present	Hi-Z	Hi-Z	Hi-Z

5.2.2 AC-DC ADAPTER AND USB PORT POWER SOURCE REGULATION SELECT (SEL)

With the SEL input Low, the MCP73871 device is designed to provide system power and Li-Ion battery charging from a USB input while adhering to the current limits governed by the USB specification. The host microcontroller has the option selecting either a 100 mA (L) or a 500 mA (H) current limit based on the PROG2 input. With the SEL input High, the MCP73871 device limits the input current to 1.8A. The programmed charge current is established using a single resistor from PROG1 to V_{SS} when driving SEL High.

MCP73871

5.2.3 USB PORT CURRENT REGULATION SELECT (PROG2)

Driving the PROG2 input to a logic Low selects the low USB port source current setting (maximum 100 mA). Driving the PROG2 input to a logic High selects the high USB port source current setting (Maximum 500 mA).

5.2.4 POWER-GOOD ($\overline{\text{PG}}$)

The power-good ($\overline{\text{PG}}$) option is a pseudo open-drain output. The $\overline{\text{PG}}$ output can sink current, but not source current. However, there is a diode path back to the input, and as such, the output should only be pulled up to the input. The $\overline{\text{PG}}$ output is low whenever the input to the MCP73871 device is above the UVLO threshold and greater than the battery voltage. The $\overline{\text{PG}}$ output can be used as an indication to the system that an input source other than the battery is supplying power.

5.2.5 TIMER ENABLE ($\overline{\text{TE}}$) OPTION

The timer enable ($\overline{\text{TE}}$) input option is used to enable or disable the internal timer. A low signal on this pin enables the internal timer and a high signal disables the internal timer. The $\overline{\text{TE}}$ input can be used to disable the timer when the charger is supplying current to charge the battery and power the system load. The $\overline{\text{TE}}$ input is compatible with 1.8V logic.

6.0 APPLICATIONS

The MCP73871 device is designed to operate in conjunction with a host microcontroller or in stand-alone applications. The MCP73871 device provides the preferred charge algorithm for Lithium-Ion

and Lithium-Polymer cells Constant-current followed by Constant-voltage. [Figure 6-1](#) depicts a typical stand-alone MCP73871 application circuit, while [Figures 6-2](#) and [6-3](#) depict the accompanying charge profile.

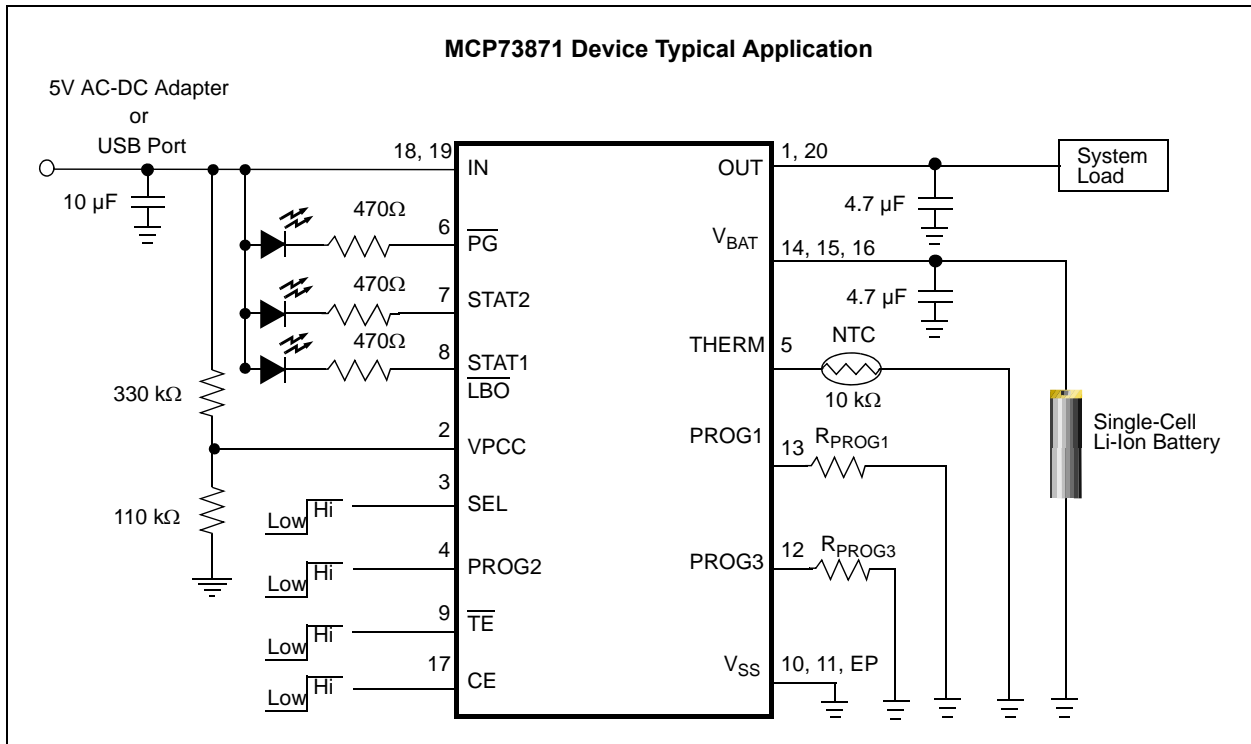

FIGURE 6-1: MCP73871 Typical Stand-Alone Application Circuit with VPCC.

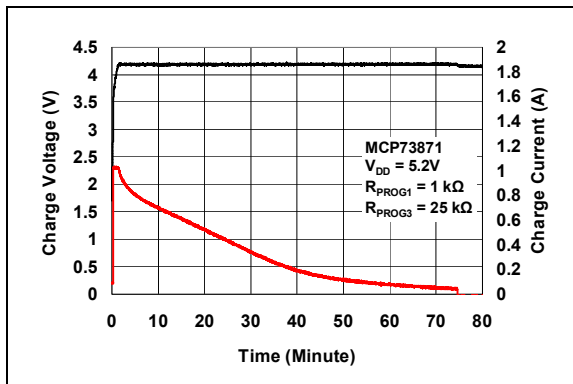

FIGURE 6-2: Typical Charge Profile (1000 mAh Battery).

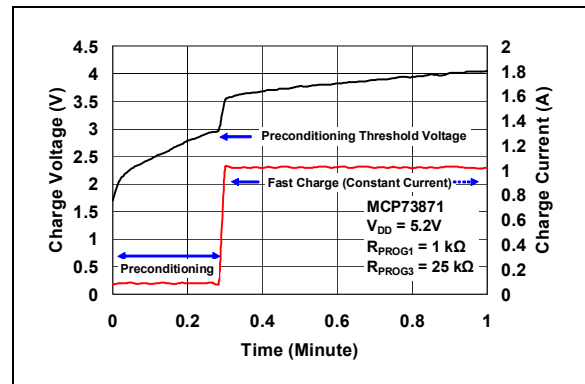

FIGURE 6-3: Typical Charge Profile in Preconditioning (1000 mAh Battery).

MCP73871

6.1 Application Circuit Design

Due to the low efficiency of linear charging, the most important factors are **thermal design** and **cost**, which are a direct function of the input voltage, output current and thermal impedance between the battery charger and the ambient cooling air. The worst-case situation is when the device has transitioned from the Preconditioning mode to the Constant Current mode. In this situation, the battery charger has to dissipate the maximum power. A trade-off must be made between the charge current, cost and thermal requirements of the charger.

6.1.1 COMPONENT SELECTION

Selection of the external components in [Figure 6-1](#) is crucial to the integrity and reliability of the charging system. The following discussion is intended as a guide for the component selection process.

6.1.1.1 Charge Current

The preferred fast charge current for Lithium-Ion cells should always follow references and guidances from battery manufacturers. For example, a 1000 mAh battery pack has a preferred fast charge current of 0.7C. Charging at 700 mA provides the shortest charge cycle times without degradation to the battery pack performance or life.

6.1.1.2 Thermal Considerations

The worst-case power dissipation in the battery charger occurs when the input voltage is at the maximum and the device has transitioned from the Preconditioning mode to the Constant-current mode. In this case, the power dissipation is:

EQUATION 6-1:

$$PowerDissipation = (V_{DDMAX} - V_{PTHMIN}) \times I_{REGMAX}$$

Where:

- V_{DDMAX} = the maximum input voltage
- I_{REGMAX} = the maximum fast charge current
- V_{PTHMIN} = the minimum transition threshold voltage

For example, power dissipation with a 5V, $\pm 10\%$ input voltage source and 500 mA, $\pm 10\%$ fast charge current is:

EXAMPLE 6-1:

$$PowerDissipation = (5.5V - 2.7V) \times 550mA = 1.54W$$

This power dissipation with the battery charger in the QFN-20 package will cause thermal regulation to be entered as depicted. Alternatively, the 4 mm x 4 mm DFN package could be utilized to reduce heat by adding vias on the exposed pad.

6.1.1.3 External Capacitors

The MCP73871 device is stable with or without a battery load. In order to maintain good AC stability in the Constant Voltage mode, a minimum capacitance of 4.7 μ F is recommended to bypass the V_{BAT} pin to V_{SS} . This capacitance provides compensation when there is no battery load. In addition, the battery and interconnections appear inductive at high frequencies. These elements are in the control feedback loop during Constant Voltage mode. Therefore, the bypass capacitance may be necessary to compensate for the inductive nature of the battery pack.

Virtually any good quality output filter capacitor can be used, independent of the capacitor's minimum Effective Series Resistance (ESR) value. The actual value of the capacitor (and its associated ESR) depends on the output load current. A 4.7 μ F ceramic, tantalum or aluminum electrolytic capacitor at the output is usually sufficient to ensure stability for charge currents up to a 1000 mA.

6.1.1.4 Reverse-Blocking Protection

The MCP73871 device provides protection from a faulted or shorted input. Without the protection, a faulted or shorted input would discharge the battery pack through the body diode of the internal pass transistor.

6.1.1.5 Temperature Monitoring

The charge temperature window can be set by placing fixed value resistors in series-parallel with a thermistor. The resistance values of R_{T1} and R_{T2} can be calculated with the following equations in order to set the temperature window of interest.

For NTC thermistors:

EQUATION 6-2:

$$24k\Omega = R_{T1} + \frac{R_{T2} \times R_{COLD}}{R_{T2} + R_{COLD}}$$

$$5k\Omega = R_{T1} + \frac{R_{T2} \times R_{HOT}}{R_{T2} + R_{HOT}}$$

Where:

- R_{T1} = the fixed series resistance
- R_{T2} = the fixed parallel resistance
- R_{COLD} = the thermistor resistance at the lower temperature of interest
- R_{HOT} = the thermistor resistance at the upper temperature of interest

For example, by utilizing a 10 k Ω at 25°C NTC thermistor with a sensitivity index, β , of 3892, the charge temperature range can be set to 0°C - 50°C by placing a 1.54 k Ω resistor in series (R_{T1}), and a 69.8 k Ω resistor in parallel (R_{T2}) with the thermistor.

6.1.1.6 Charge Status Interface

A status output provides information on the state of charge. The output can be used to illuminate external LEDs or interface to a host microcontroller. Refer to [Table 5-1](#) for a summary of the state of the status output during a charge cycle.

6.1.1.7 System Load Current

The preferred discharge current for Lithium-Ion cells should always follow references and guidance from battery manufacturers. Due to the safety concerns when using Lithium-Ion batteries and power dissipation of linear solutions, the system load when design with the MCP73871 device is recommended to be less than 1A or the maximum discharge rate of the selected Lithium-Ion cell. Whichever is smaller is recommended.

The idea diode between V_{BAT} and OUT is designed to drive a maximum current up to 2A. The built-in thermal shutdown protection may turn the MCP73871 device off with high current.

6.2 PCB Layout Issues

For optimum voltage regulation, place the battery pack as close as possible to the device's V_{BAT} and V_{SS} pins, recommended to minimize voltage drops along the high current-carrying PCB traces.

If the PCB layout is used as a heatsink, adding many vias in the heatsink pad can help conduct more heat to the backplane of the PCB, thus reducing the maximum junction temperature.

MCP73871

NOTES:

7.0 PACKAGING

7.1 Package Marking Information

20-Lead QFN



Part Number *	Marking Code	Part Number *	Marking Code
MCP73871-1AAI/ML	1AA	MCP73871T-1AAI/ML	1AA
MCP73871-1CAI/ML	1CA	MCP73871T-1CAI/ML	1CA
MCP73871-1CCI/ML	1CC	MCP73871T-1CCI/ML	1CC
MCP73871-2AAI/ML	2AA	MCP73871T-2AAI/ML	2AA
MCP73871-2CAI/ML	2CA	MCP73871T-2CAI/ML	2CA
MCP73871-2CCI/ML	2CC	MCP73871T-2CCI/ML	2CC
MCP73871-3CAI/ML	3CA	MCP73871T-3CAI/ML	3CA
MCP73871-3CCI/ML	3CC	MCP73871T-3CCI/ML	3CC
MCP73871-4CAI/ML	4CA	MCP73871T-4CAI/ML	4CA
MCP73871-4CCI/ML	4CC	MCP73871T-4CCI/ML	4CC

Example:

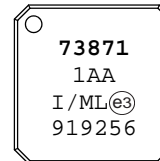

* Consult Factory for Alternative Device Options.

Legend: XX...X Customer-specific information
 Y Year code (last digit of calendar year)
 YY Year code (last 2 digits of calendar year)
 WW Week code (week of January 1 is week '01')
 NNN Alphanumeric traceability code
 (e3) Pb-free JEDEC designator for Matte Tin (Sn)
 * This package is Pb-free. The Pb-free JEDEC designator (e3) can be found on the outer packaging for this package.

Note: In the event the full Microchip part number cannot be marked on one line, it will be carried over to the next line, thus limiting the number of available characters for customer-specific information.

MCP73871

20-Lead Plastic Quad Flat, No Lead Package (ML) – 4x4x0.9 mm Body [QFN]

Note: For the most current package drawings, please see the Microchip Packaging Specification located at <http://www.microchip.com/packaging>

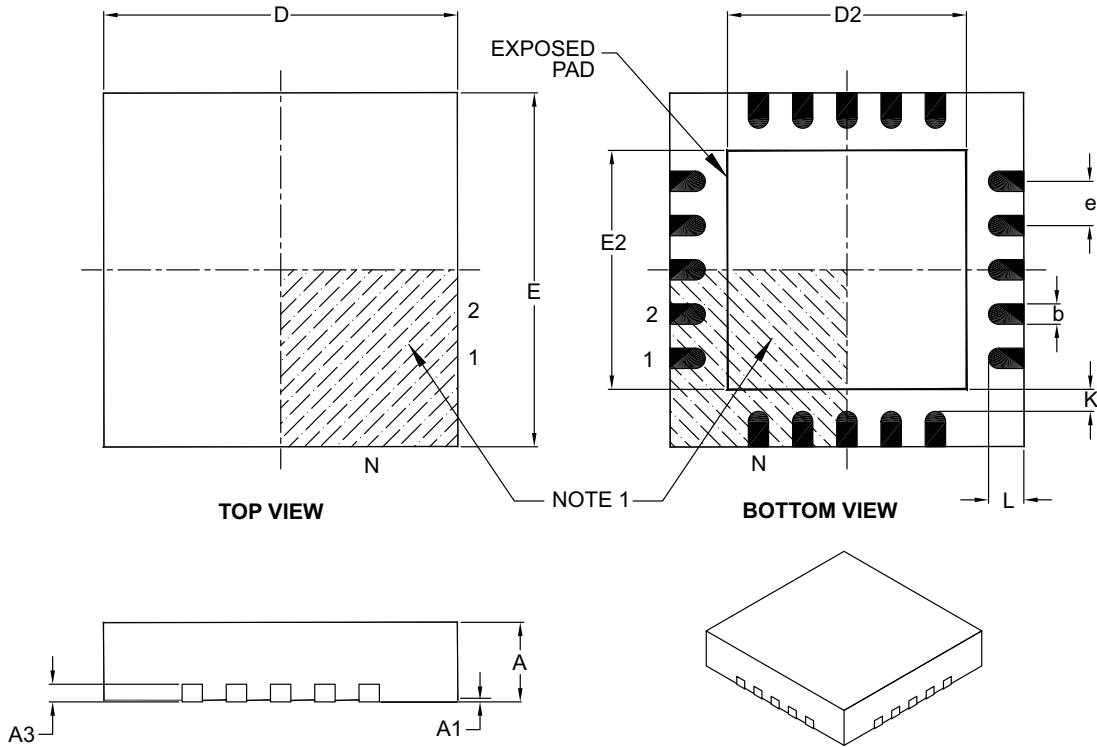

Dimension Limits	Units	MILLIMETERS		
		MIN	NOM	MAX
Number of Pins	N	20		
Pitch	e	0.50 BSC		
Overall Height	A	0.80	0.90	1.00
Standoff	A1	0.00	0.02	0.05
Contact Thickness	A3	0.20 REF		
Overall Width	E	4.00 BSC		
Exposed Pad Width	E2	2.60	2.70	2.80
Overall Length	D	4.00 BSC		
Exposed Pad Length	D2	2.60	2.70	2.80
Contact Width	b	0.18	0.25	0.30
Contact Length	L	0.30	0.40	0.50
Contact-to-Exposed Pad	K	0.20	–	–

Notes:

- Pin 1 visual index feature may vary, but must be located within the hatched area.
- Package is saw singulated.
- Dimensioning and tolerancing per ASME Y14.5M.

BSC: Basic Dimension. Theoretically exact value shown without tolerances.

REF: Reference Dimension, usually without tolerance, for information purposes only.

Microchip Technology Drawing C04-126B

20-Lead Plastic Quad Flat, No Lead Package (ML) - 4x4 mm Body [QFN]
With 0.40 mm Contact Length

Note: For the most current package drawings, please see the Microchip Packaging Specification located at <http://www.microchip.com/packaging>

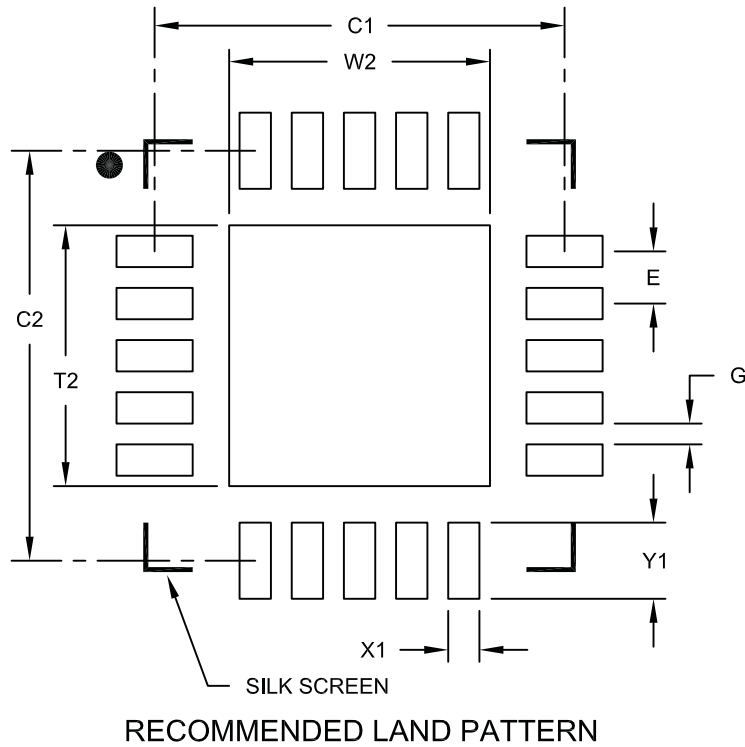

Dimension Limits	Units	MILLIMETERS		
		MIN	NOM	MAX
Contact Pitch	E	0.50 BSC		
Optional Center Pad Width	W2			2.50
Optional Center Pad Length	T2			2.50
Contact Pad Spacing	C1		3.93	
Contact Pad Spacing	C2		3.93	
Contact Pad Width	X1			0.30
Contact Pad Length	Y1			0.73
Distance Between Pads	G	0.20		

Notes:

1. Dimensioning and tolerancing per ASME Y14.5M

BSC: Basic Dimension. Theoretically exact value shown without tolerances.

Microchip Technology Drawing No. C04-2126A

MCP73871

NOTES:

APPENDIX A: REVISION HISTORY

Revision B (May 2009)

The following is the list of modifications:

1. Updated the QFN-20 package drawing.
2. Updated [Equation 4-1](#).
3. Updated **Section 4.7 “Charge Termination”** and [Equation 4-2](#).
4. Updated [Equation 5-1](#).

Revision A (July 2008)

- Original Release of this Document.

MCP73871

NOTES:

PRODUCT IDENTIFICATION SYSTEM

To order or obtain information, e.g., on pricing or delivery, refer to the factory or the listed sales office.

<u>PART NO.</u>	<u>XX</u>	<u>X/</u>	<u>XX</u>
Device	Output Options*	Temp.	Package
<p>Device: MCP73871: USB/AC Battery Charger with PPM MCP73871T: USB/AC Battery Charger with PPM (Tape and Reel)</p> <p>Output Options ** * Refer to table below for different operational options. ** Consult Factory for Alternative Device Options.</p> <p>Temperature: I = -40°C to +85°C</p> <p>Package Type: ML = Plastic Quad Flat No Lead (QFN) (4x4x0.9 mm Body), 20-lead</p>			
<p>Examples: **</p> <p>a) MCP73871-1AAI/ML: 4.10V PPM Battery Charger, 20LD QFN pkg.</p> <p>b) MCP73871-1CAI/ML: 4.10V, PPM Battery Charger, 20LD QFN pkg.</p> <p>c) MCP73871-1CCI/ML: 4.10V, PPM Battery Charger, 20LD QFN pkg.</p> <p>d) MCP73871-2AAI/ML: 4.20V, PPM Battery Charger, 20LD QFN pkg.</p> <p>e) MCP73871-2CAI/ML: 4.20V PPM Battery Charger, 20LD QFN pkg.</p> <p>f) MCP73871-2CCI/ML: 4.20V PPM Battery Charger, 20LD QFN pkg.</p> <p>g) MCP73871-3CAI/ML: 4.35V PPM Battery Charger, 20LD QFN pkg.</p> <p>h) MCP73871-3CCI/ML: 4.35V PPM Battery Charger, 20LD QFN pkg.</p> <p>** Consult Factory for Alternative Device Options</p>			

* Operational Output Options

Output Options	V _{REG}	Safety Timer Duration (Hours)	LBO Voltage Threshold (V)
1AA	4.10V	Disable	Disabled
1CA	4.10V	6	Disabled
1CC	4.10V	6	3.1
2AA	4.20V	Disable	Disabled
2CA	4.20V	6	Disabled
2CC	4.20V	6	3.1
3CA	4.35V	6	Disabled
3CC	4.35V	6	3.1
4CA	4.40V	6	Disabled
4CC	4.40V	6	3.1

** Consult Factory for Alternative Device Options.

MCP73871

NOTES:

Note the following details of the code protection feature on Microchip devices:

- Microchip products meet the specification contained in their particular Microchip Data Sheet.
- Microchip believes that its family of products is one of the most secure families of its kind on the market today, when used in the intended manner and under normal conditions.
- There are dishonest and possibly illegal methods used to breach the code protection feature. All of these methods, to our knowledge, require using the Microchip products in a manner outside the operating specifications contained in Microchip's Data Sheets. Most likely, the person doing so is engaged in theft of intellectual property.
- Microchip is willing to work with the customer who is concerned about the integrity of their code.
- Neither Microchip nor any other semiconductor manufacturer can guarantee the security of their code. Code protection does not mean that we are guaranteeing the product as “unbreakable.”

Code protection is constantly evolving. We at Microchip are committed to continuously improving the code protection features of our products. Attempts to break Microchip's code protection feature may be a violation of the Digital Millennium Copyright Act. If such acts allow unauthorized access to your software or other copyrighted work, you may have a right to sue for relief under that Act.

Information contained in this publication regarding device applications and the like is provided only for your convenience and may be superseded by updates. It is your responsibility to ensure that your application meets with your specifications. MICROCHIP MAKES NO REPRESENTATIONS OR WARRANTIES OF ANY KIND WHETHER EXPRESS OR IMPLIED, WRITTEN OR ORAL, STATUTORY OR OTHERWISE, RELATED TO THE INFORMATION, INCLUDING BUT NOT LIMITED TO ITS CONDITION, QUALITY, PERFORMANCE, MERCHANTABILITY OR FITNESS FOR PURPOSE. Microchip disclaims all liability arising from this information and its use. Use of Microchip devices in life support and/or safety applications is entirely at the buyer's risk, and the buyer agrees to defend, indemnify and hold harmless Microchip from any and all damages, claims, suits, or expenses resulting from such use. No licenses are conveyed, implicitly or otherwise, under any Microchip intellectual property rights.

Trademarks

The Microchip name and logo, the Microchip logo, Accuron, dsPIC, KEELOQ, KEELOQ logo, MPLAB, PIC, PICmicro, PICSTART, rfPIC, SmartShunt and UNI/O are registered trademarks of Microchip Technology Incorporated in the U.S.A. and other countries.

FilterLab, Hampshire, Linear Active Thermistor, MXDEV, MXLAB, SEEVAL, SmartSensor and The Embedded Control Solutions Company are registered trademarks of Microchip Technology Incorporated in the U.S.A.

Analog-for-the-Digital Age, Application Maestro, CodeGuard, dsPICDEM, dsPICDEM.net, dsPICworks, dsSPEAK, ECAN, ECONOMONITOR, FanSense, In-Circuit Serial Programming, ICSP, ICEPIC, Mindi, MiWi, MPASM, MPLAB Certified logo, MPLIB, MPLINK, mTouch, nanoWatt XLP, PICkit, PICDEM, PICDEM.net, PICtail, PIC³² logo, PowerCal, PowerInfo, PowerMate, PowerTool, REAL ICE, rfLAB, Select Mode, Total Endurance, TSHARC, WiperLock and ZENA are trademarks of Microchip Technology Incorporated in the U.S.A. and other countries.

SQTP is a service mark of Microchip Technology Incorporated in the U.S.A.

All other trademarks mentioned herein are property of their respective companies.

© 2009, Microchip Technology Incorporated, Printed in the U.S.A., All Rights Reserved.

 Printed on recycled paper.

QUALITY MANAGEMENT SYSTEM
CERTIFIED BY DNV
== ISO/TS 16949:2002 ==

Microchip received ISO/TS-16949:2002 certification for its worldwide headquarters, design and wafer fabrication facilities in Chandler and Tempe, Arizona; Gresham, Oregon and design centers in California and India. The Company's quality system processes and procedures are for its PIC® MCUs and dsPIC® DSCs, KEELOQ® code hopping devices, Serial EEPROMs, microperipherals, nonvolatile memory and analog products. In addition, Microchip's quality system for the design and manufacture of development systems is ISO 9001:2000 certified.



WORLDWIDE SALES AND SERVICE

AMERICAS

Corporate Office
2355 West Chandler Blvd.
Chandler, AZ 85224-6199
Tel: 480-792-7200
Fax: 480-792-7277
Technical Support:
<http://support.microchip.com>
Web Address:
www.microchip.com

Atlanta
Duluth, GA
Tel: 678-957-9614
Fax: 678-957-1455

Boston
Westborough, MA
Tel: 774-760-0087
Fax: 774-760-0088

Chicago
Itasca, IL
Tel: 630-285-0071
Fax: 630-285-0075

Cleveland
Independence, OH
Tel: 216-447-0464
Fax: 216-447-0643

Dallas
Addison, TX
Tel: 972-818-7423
Fax: 972-818-2924

Detroit
Farmington Hills, MI
Tel: 248-538-2250
Fax: 248-538-2260

Kokomo
Kokomo, IN
Tel: 765-864-8360
Fax: 765-864-8387

Los Angeles
Mission Viejo, CA
Tel: 949-462-9523
Fax: 949-462-9608

Santa Clara
Santa Clara, CA
Tel: 408-961-6444
Fax: 408-961-6445

Toronto
Mississauga, Ontario,
Canada
Tel: 905-673-0699
Fax: 905-673-6509

ASIA/PACIFIC

Asia Pacific Office
Suites 3707-14, 37th Floor
Tower 6, The Gateway
Harbour City, Kowloon
Hong Kong
Tel: 852-2401-1200
Fax: 852-2401-3431

Australia - Sydney
Tel: 61-2-9868-6733
Fax: 61-2-9868-6755

China - Beijing
Tel: 86-10-8528-2100
Fax: 86-10-8528-2104

China - Chengdu
Tel: 86-28-8665-5511
Fax: 86-28-8665-7889

China - Hong Kong SAR
Tel: 852-2401-1200
Fax: 852-2401-3431

China - Nanjing
Tel: 86-25-8473-2460
Fax: 86-25-8473-2470

China - Qingdao
Tel: 86-532-8502-7355
Fax: 86-532-8502-7205

China - Shanghai
Tel: 86-21-5407-5533
Fax: 86-21-5407-5066

China - Shenyang
Tel: 86-24-2334-2829
Fax: 86-24-2334-2393

China - Shenzhen
Tel: 86-755-8203-2660
Fax: 86-755-8203-1760

China - Wuhan
Tel: 86-27-5980-5300
Fax: 86-27-5980-5118

China - Xiamen
Tel: 86-592-2388138
Fax: 86-592-2388130

China - Xian
Tel: 86-29-8833-7252
Fax: 86-29-8833-7256

China - Zhuhai
Tel: 86-756-3210040
Fax: 86-756-3210049

ASIA/PACIFIC

India - Bangalore
Tel: 91-80-3090-4444
Fax: 91-80-3090-4080

India - New Delhi
Tel: 91-11-4160-8631
Fax: 91-11-4160-8632

India - Pune
Tel: 91-20-2566-1512
Fax: 91-20-2566-1513

Japan - Yokohama
Tel: 81-45-471- 6166
Fax: 81-45-471-6122

Korea - Daegu
Tel: 82-53-744-4301
Fax: 82-53-744-4302

Korea - Seoul
Tel: 82-2-554-7200
Fax: 82-2-558-5932 or
82-2-558-5934

Malaysia - Kuala Lumpur
Tel: 60-3-6201-9857
Fax: 60-3-6201-9859

Malaysia - Penang
Tel: 60-4-227-8870
Fax: 60-4-227-4068

Philippines - Manila
Tel: 63-2-634-9065
Fax: 63-2-634-9069

Singapore
Tel: 65-6334-8870
Fax: 65-6334-8850

Taiwan - Hsin Chu
Tel: 886-3-6578-300
Fax: 886-3-6578-370

Taiwan - Kaohsiung
Tel: 886-7-536-4818
Fax: 886-7-536-4803

Taiwan - Taipei
Tel: 886-2-2500-6610
Fax: 886-2-2508-0102

Thailand - Bangkok
Tel: 66-2-694-1351
Fax: 66-2-694-1350

EUROPE

Austria - Wels
Tel: 43-7242-2244-39
Fax: 43-7242-2244-393

Denmark - Copenhagen
Tel: 45-4450-2828
Fax: 45-4485-2829

France - Paris
Tel: 33-1-69-53-63-20
Fax: 33-1-69-30-90-79

Germany - Munich
Tel: 49-89-627-144-0
Fax: 49-89-627-144-44

Italy - Milan
Tel: 39-0331-742611
Fax: 39-0331-466781

Netherlands - Drunen
Tel: 31-416-690399
Fax: 31-416-690340

Spain - Madrid
Tel: 34-91-708-08-90
Fax: 34-91-708-08-91

UK - Wokingham
Tel: 44-118-921-5869
Fax: 44-118-921-5820