

* Records of Revision *

Rev.	Page	Description of changes	Date	prepared by
0	All	Original Release	09.12.23	Little Fan

一般事项 特殊事项
 特殊事项内容：

* Contents *

1. Features
2. Mechanical Specifications
3. Absolute Maximum Ratings
4. Electrical Characteristics
5. Recommended Software Setting Value (Initial Code)
6. Back Light System Characteristics
7. Optical Characteristics
8. Block Diagram
9. Interface Pin Assignment
10. Power Supply Sequence
11. Read/Write Timing characteristics (80 series MPU)
12. External Dimension
13. LCD Module Numbering System
14. Package Terms
15. LCD Module Out-Going Quality Level
16. BOE Customer Quality Service Process
17. LCD Module Operation Instruction

1. Features

The features of BTL221722-276L are as follows

- * Display mode : TFT 262K Colors, Transmissive, Normally White
- * Driving Condition : 176x3Ch-Source / 220Ch-Gate
- * Connection : Soldering Type
- * LCD Driver & Control IC : HX8340B(N) (Himax)
- * Back Light : White LED Back Light (3 Chips in Parallel)
- * MPU Interface : Serial Peripheral Interface
- * Type of Surface Condition : Clear Type

2. Mechanical Specifications

Item		Specification	Unit
Resolution	Main	176(x RGB) x 220	Dot
	Sub	NA	
LCM Outline Demension		40.3x55.26x2.35(without D/A tape)	mm
Active Area (W × H)	Main	34.848X43.56	mm
	Sub	NA	
Pixel Pitch (W x H)	Main	0.066X0.198	mm
	Sub	NA	
Viewing Direction (Human Eye)	Main	6	O'clock
	Sub	NA	
Gray Scale Inversion Direction (Contrast Ratio)	Main	12	O'clock (Rubbing Direction)
	Sub	NA	
Weight		About 12	g

Model	BTL221722-276L	4/28	PRODUCT SPECIFICATION
-------	----------------	------	-----------------------

3. Absolute Maximum Ratings

(Ta=25°C Note1)

Items	Symbol	Min.	Max.	Unit	Remark
Logic voltage	I_{OVCC}	-0.3	3.6	V	
Analoge voltage	V_{CI}	-0.3	4.2	V	
Input signal voltage	V_{IN}	-0.3	$I_{OVCC}+0.5$	V	
LED forward current	I_{LED}	-	25	mA	For each LED
Operation temeprature	T_{OPR}	-20	70	°C	
Storage temperature	T_{STG}	-30	80	°C	
Humidity (ambient temeprature=Ta)		$Ta \leq 60^{\circ}C$	90% RH Max.		

Note1 : Device is subject to be damaged permanently,
if stresses beyond those absolute maximum ratings listed above.

4. Electrical Characteristics

Main		Ta=25°C					
Items	Symbol	Min.	Typ.	Max.	Unit	Remark	
Logic voltage	I_{OVCC}	1.65	2.8	3.3	V		
Analog(Power) voltage	V_{CC}	2.72	2.8	2.88	V		
Gate voltage	High level	V_{GH}	12	-	18	V	Note 1
	Low level	V_{GL}	-11	-	-7	V	
Input signal voltage	High level	V_{IH}	$0.7 \times I_{OVCC}$	-	I_{OVCC}	V	
	Low level	V_{IL}	VSSD	-	$0.3 \times I_{OVCC}$	V	
current consumption	I_{CC}	-	3	5	mA	Note 2	

Note 1) The value can be adjusted by software to optimize display quality

Note 2) Display Black Pattern

5. Recommended Software Setting Value (LDI: HX8340B(N))

Initial Code

INDEX	DATA	INDEX	DATA
Power On			0x07
	100ms delay or more		0x05
Hardware Reset			0x33
	50ms delay or more	10ms delay or more	
0xC1	0xFF	0xB5	0x35
	0x83		0x20
	0x40		0x45
0x11		0xB4	0x33
	150ms delay or more		0x25
0xCA	0x70		0x4C
	0x00	10ms delay or more	
	0xD9	0x3A	0x05
0xB0	0x01	Display ON Setting	
	0x11	0x29	-
Driving ability Setting		10ms delay or more	
0xC9	0x90	Set GRAM Area	
	0x49	0x2A	0x00
	0x10		0x00
	0x28		0x00
	0x28		0xAF
	0x10	0x2B	0x00
	0x00		0x00
	0x06		0x00
	20ms delay or more		0xDB
Gamma 2.2 Setting		Start GRAM write	
0xC2	0x60	0x2C	Display Data
	0x71		
	0x01		
	0x0E		
	0x05		
	0x02		
	0x09		
	0x31		
	0x0A		
0xC3	0x67		
	0x30		
	0x61		
	0x17		
	0x48		

Into Sleep Mode

INDEX	DATA
0x28	
	10ms delay or more
0x10	
	120ms delay or more

Exit Sleep Mode

INDEX	DATA
0x29	
	10ms delay or more
0x11	
	120ms delay or more

Windows Display Setting

INDEX	DATA
0x2A	Start Column
	Start Column
	End Column
	End Column
0x2B	Start Row
	Start Row
	End Row
	End Row

Note: R3Ah=0x06 ,262K colors
R3Ah=0x05 ,65K colors

NOTE: BOE requires the customer to follow the above instructions strictly. If customer would like to change the above instructions, the customer should inform BOE and get re-check from BOE, or the customer will be responsible for any unexpected result because of the change.

Model	BTL221722-276L	7/28	PRODUCT SPECIFICATION
-------	----------------	------	-----------------------

6. Back Light System Characteristics

Ta=25°C

Items	Symbol	Min.	Typ.	Max.	Unit	Remark
Forward current	If	-	18	20	mA	Note1
Forward voltage	Vf	3.0	-	3.4	V	Note1
B/L Power consumption	P_{BL}	-	-	205	mW	Note2

Note 1: The Driving condition is defined for each LED chip.

Note 2: The B/L Power consumption is defined for the backlight module.the schematic drawing of the backlight module as the figure.

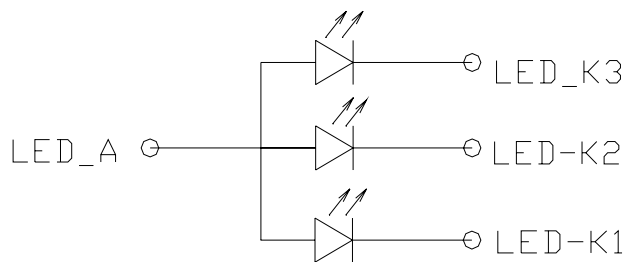

Ref. Total power consumption(max) depends on LED current/ LED driver efficiency, etc.

7. Optical Characteristics

Transmissive Mode

Ta=25°C

Item	Symbol	Min.	Typ.	Max.	Unit	Condition	Note	
Viewing Angle	θ	$\varnothing=0^\circ$ (X1)	-	45	-	deg.	Cr > 10	Note2
		$\varnothing=180^\circ$ (X2)	-	45	-			
		$\varnothing=90^\circ$ (Y1)	-	35	-			
		$\varnothing=270^\circ$ (Y2)	-	15	-			
Contrast ratio (transmissive)	Cr	230	440	-	-	$\theta = 0$ $\varnothing = 0$	Note1 Note4	
Response Time	Tr + Tf	-	25	-	ms	$\theta = 0$ $\varnothing = 0$	Note3	
CIE Coordi- -nate	R	(x,y)	0.55,0.29	0.59,0.33	0.63,0.37	$\theta = 0$ $\varnothing = 0$		
	G	(x,y)	0.29,0.56	0.33,0.60	0.37,0.64			
	B	(x,y)	0.11,0.06	0.15,0.10	0.19,0.14			
	W	(x,y)	0.25,0.27	0.29,0.31	0.33,0.35			
Brightness	L	270	340	-	cd/m ²	18mA/LED	Note5	
Uniformity		70	-	-		18mA/LED	Note6	

* $\varnothing = 0^\circ$, $\varnothing = 90^\circ$, $\varnothing = 180^\circ$, $\varnothing = 270^\circ$ means viewing direction.

* B/L is turned on.

Model

BTL221722-276L

9/28

PRODUCT SPECIFICATION

The optical characteristics should be measured in dark room, and after 5 minutes operation, the measurement begin.

Note1. Definition of Measure System

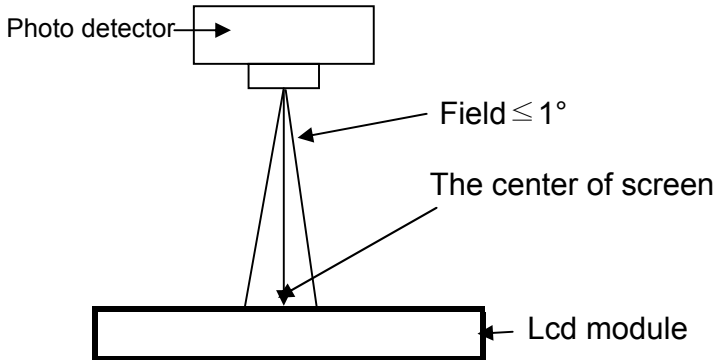

Note2. Definition of Angle Θ .

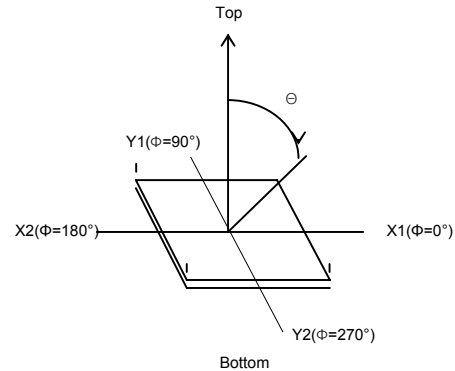

Note3. Definition of Response Time

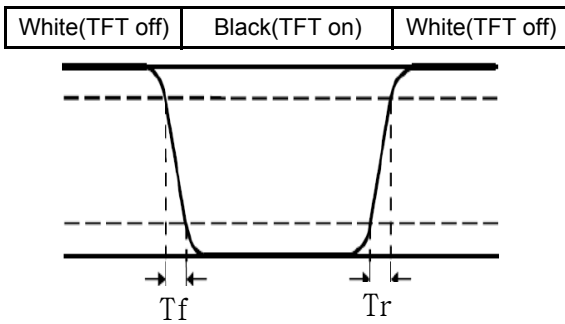

Note4.definition of contrast ratio

$$Cr = \frac{\text{Liuminance of LCD white state}}{\text{Liuminance of LCD Black state}}$$

Note 5. Measuring Point(9 Points) (WxH)

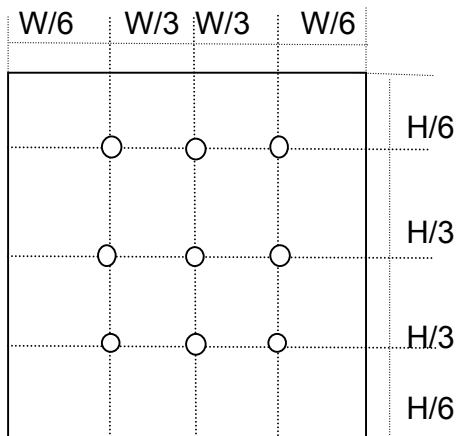

Rating is defined as the average brightness inside the viewing area

Note 6. definition of Uniformity

$$\text{Uniformity} = \frac{\text{max. Liuminance of measurede point}}{\text{max. Liuminance of measurede poin}}$$

Model

BTL221722-276L

10/28

PRODUCT SPECIFICATION

8. Block Diagram

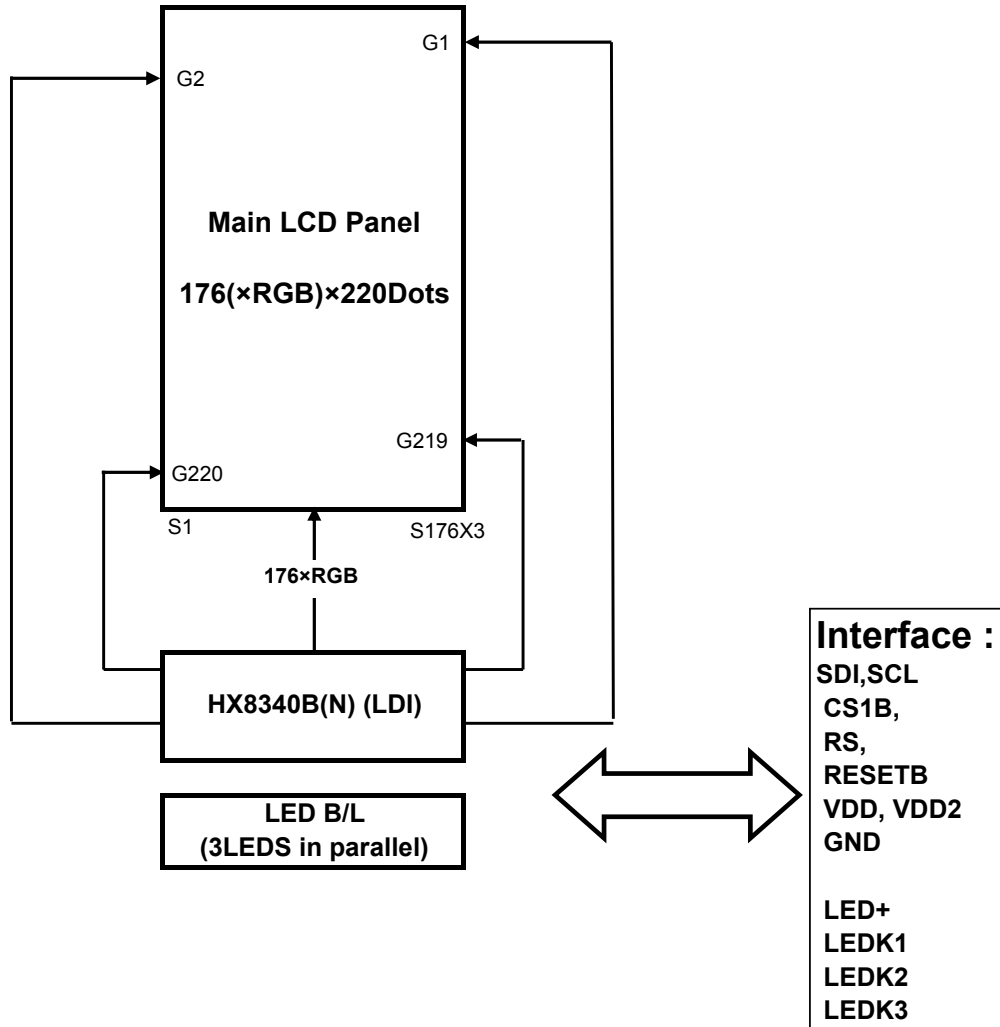

Model

BTL221722-276L

11/28

PRODUCT SPECIFICATION

9. Interface Pin Assignment

No	Symbol	Description
1	VSS	Ground
2	NC	No Connection
3	LED+	LED Anode(+)
4	VDD2	VDD,Power Supply for Internal Logic(1.8V or 2.8V)
5	CS1B	Chip Select Signal(low active)
6	SDI	Serial data input/output PIN
7	SCL	Serial clock
8	RS	Not use(Connect to IOVCC or GND)
9	RESETB	Hardware Reset Signal
10	VDD	VCI,Power Supply 2.8V
11	LEDK1	LED Cathode(-)
12	LEDK2	LED Cathode(-)
13	LEDK3	LED Cathode(-)
14	VSS	Ground

10. Power Supply Sequence

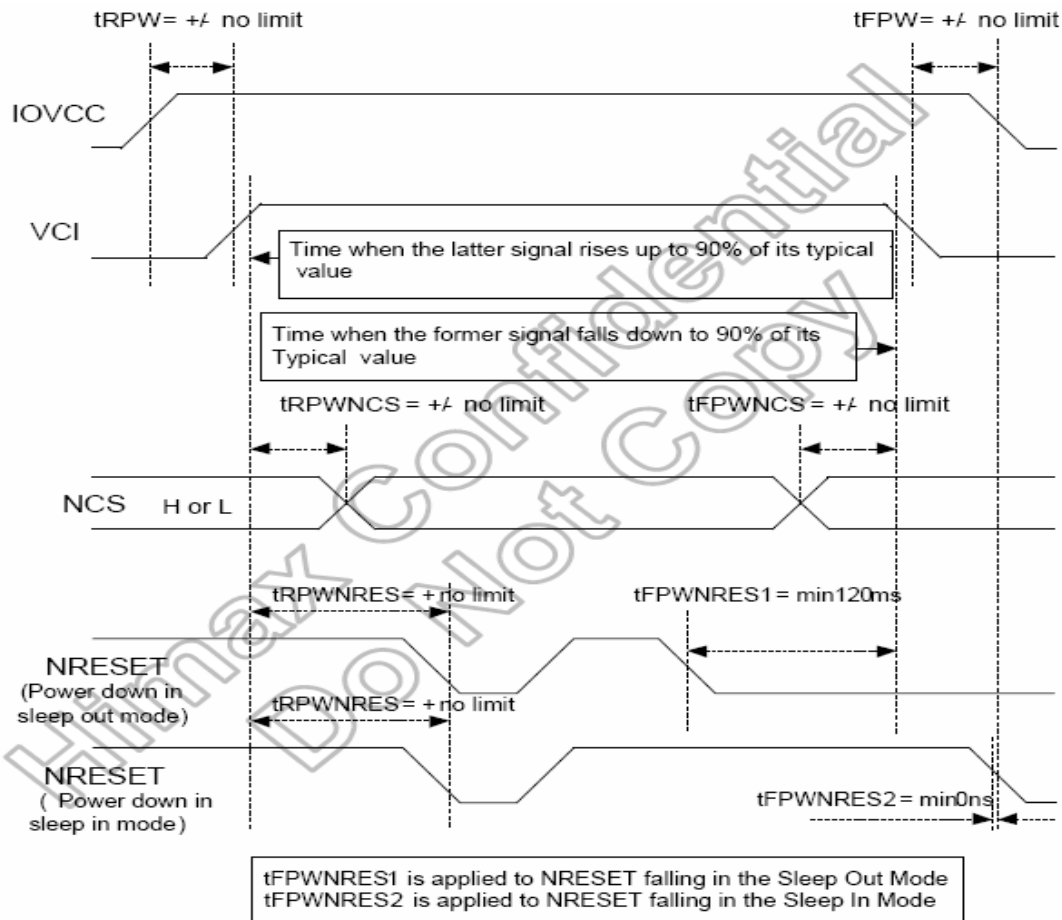

Power source IOVCC, VCI can be applied and powered down in any order.

IOVCC, VCI can be powered down in any order.

During power off, if LCD is in the Sleep Out mode, IOVCC, VCI must be powered down minimum 120msec after NRESET has been released.

During power off, if LCD is in the Sleep In mode, IOVCC, VCI can be powered down minimum 0msec after NRESET has been released.

NCS can be applied at any timing or can be permanently grounded. NRESET has priority over NCS.

Note: (1) There will be no damage to the display module if the power sequences are not met.

(2) There will be no abnormal visible effects on the display panel during the Power On/Off Sequences.

(3) There will be no abnormal visible effects on the display between end of Power on Sequence and before receiving Sleep Out command. Also between receiving Sleep In command and Power Off Sequence.

11. Read/Write Timing characteristics (80 series MPU)

1) Read/Write Timing

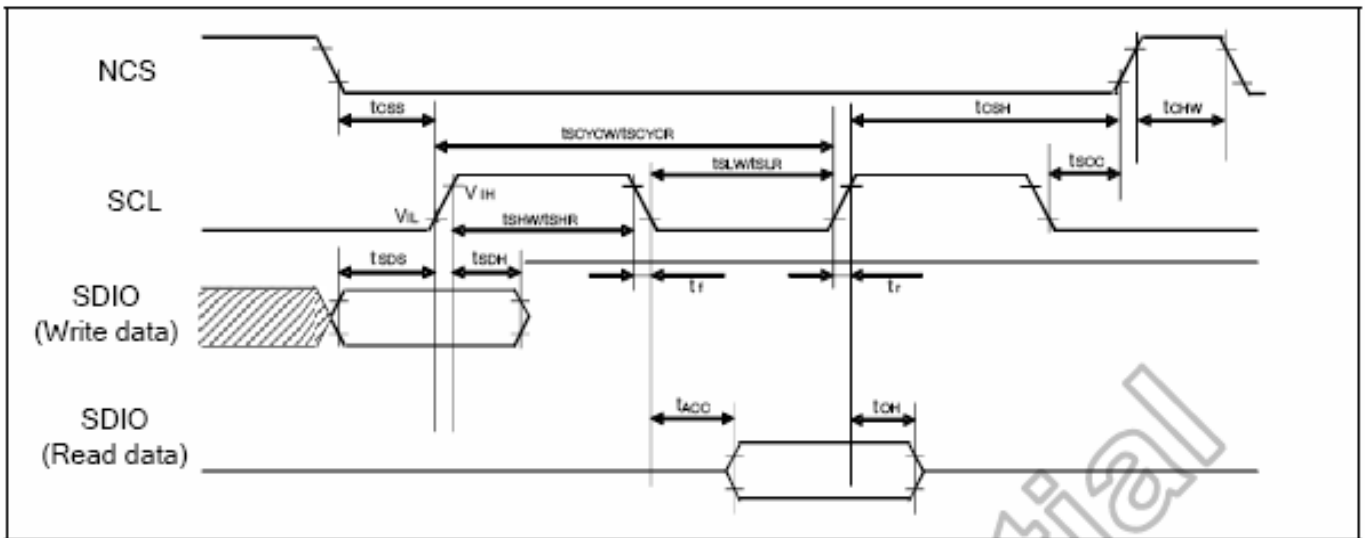

Parameter	Symbol	Conditions	Min.	Typ.	Max.	Unit
Serial clock cycle (Write)	t_{scyww}		66		-	
SCL "H" pulse width (Write)	t_{shw}	SCL	15		-	ns
SCL "L" pulse width (Write)	t_{shl}		15		-	
Data setup time (Write)	t_{sdh}	SDIO	10		-	ns
Data hold time (Write)	t_{sdh}		10		-	
Serial clock cycle (Read)	t_{scywr}		150		-	
SCL "H" pulse width (Read)	t_{shr}	SCL	60		-	ns
SCL "L" pulse width (Read)	t_{slr}		60		-	
Access Time	t_{acc}	SDI for maximum $C_L=30pF$ For minimum $C_L=8pF$	10		50	ns
Output disable time	t_{oh}	SDO For maximum $C_L=30pF$ For minimum $C_L=8pF$	15		50	ns
SCL to Chip select	t_{cc}	SCL, NCS	20			ns
NCS "H" pulse width	t_{chh}	NCS	40			ns
Chip select setup time	t_{css}	NCS	15		-	ns
Chip select hold time	t_{chh}		15		-	

Note: The input signal rise time and fall time (t_r , t_f) is specified at 15 ns or less.

Logic high and low levels are specified as 30% and 70% of IOVCC for Input signals.

Input Signal Slope

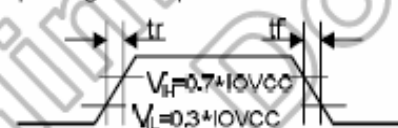

Output Signal Slope

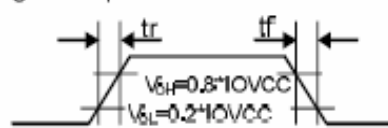

Model

BTL221722-276L

14/28

PRODUCT SPECIFICATION

2) Reset Timing characteristics

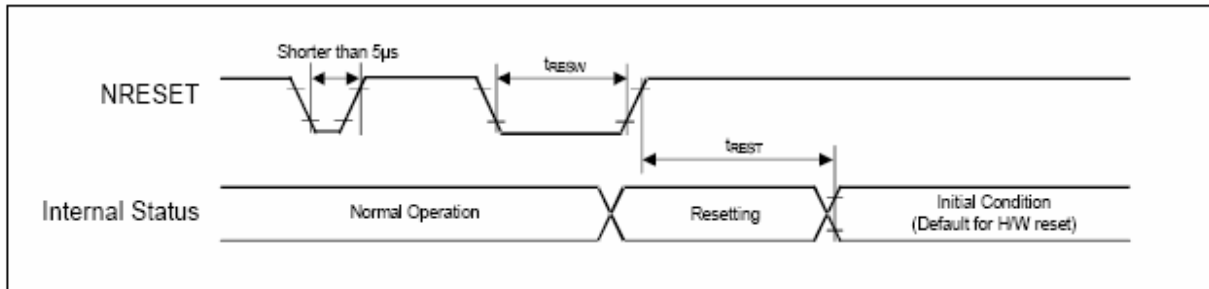

Figure 11. 6 Reset Input Timing

Symbol	Parameter	Related Pins	Min.	Typ.	Max.	Note	Unit
t_{RESW}	*1) Reset low pulse width	NRESET	10	-	-	-	μs
t_{REST}	*2) Reset complete time	-	-	-	5	When reset applied during Sleep In mode	ms
		-	-	-	120	When reset applied during Sleep Out mode	ms

Note:

1. Spike due to an electrostatic discharge on !RES line does not cause irregular system reset according to the following table.

NRESET Pulse	Action
Shorter than 5 μ	Reset Rejected
Longer than 10 μ s	Reset
Between 5 μ s and 10 μ s	Reset Start

2. During the resetting period, the display will be blanked (The display is entering blanking sequence, which maximum time is 120 ms, when Reset Starts in Sleep Out mode. The display remains the blank state in Sleep In mode) and then return to Default condition for H/W reset.
3. During Reset Complete Time, ID2 and VCOMOF value in OTP will be latched to internal register during this period. This loading is done every time when there is H/W reset complete time (t_{REST}) within 5ms after a rising edge of RESET.
4. Spike Rejection also applies during a valid reset pulse as shown as below:

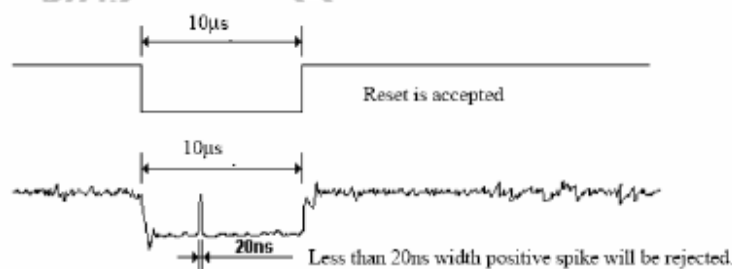

5. It is necessary to wait 5msec after releasing RESET before sending commands. Also Sleep Out command cannot be sent for 120msec.

Model

BTL221722-276L

15/28

PRODUCT SPECIFICATION

12. External Dimension

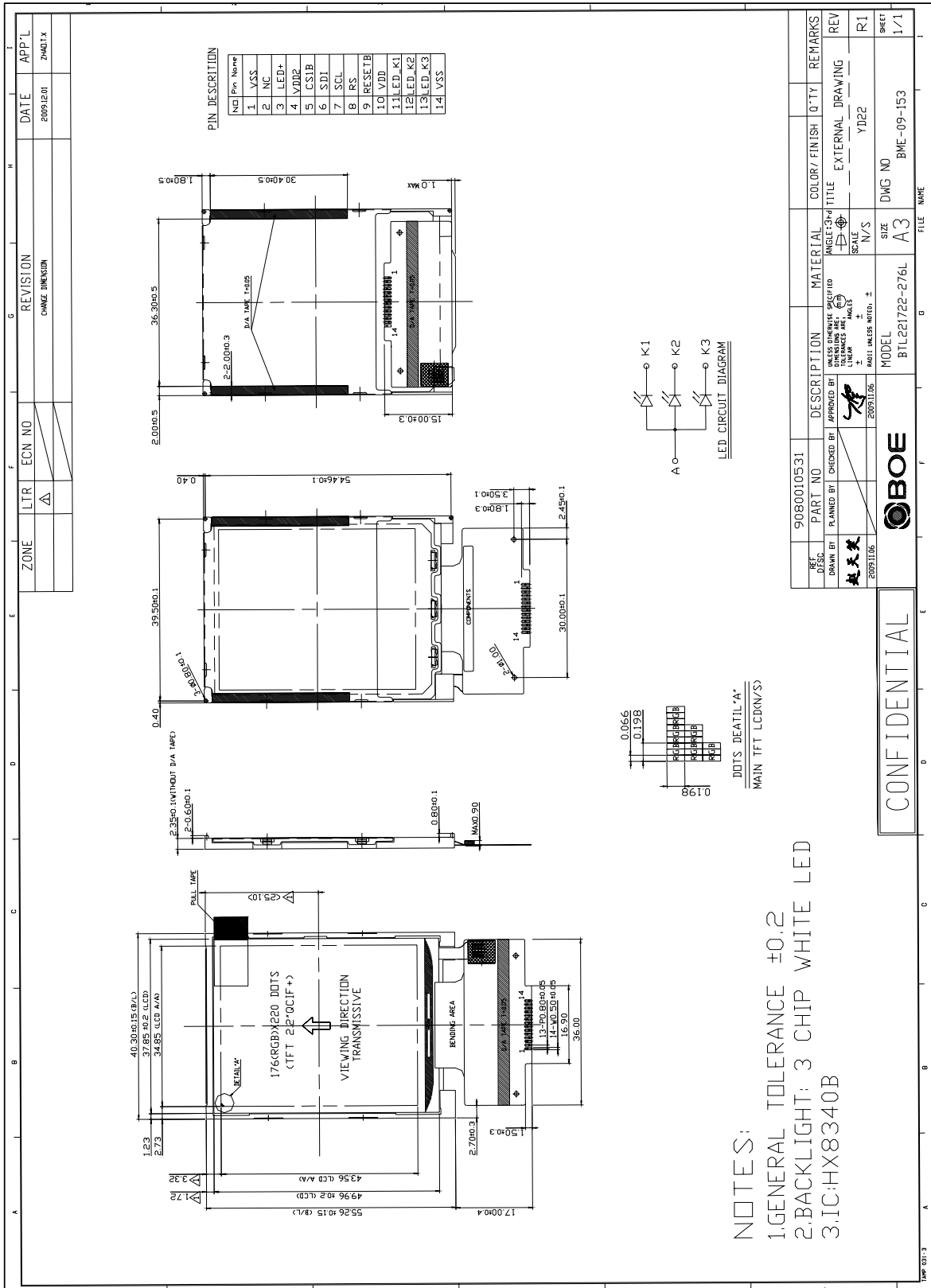

Model

BTL221722-276L

16/28

PRODUCT SPECIFICATION

13.COLOR LCD MODULE NUMBERING SYSTEM

B	T	L	2	2	1	7	2	2			2	7	6	L		
(1)	(2)	(3)	(4)	(5)			(6)		(7)			(8)	(9)	(10)		

(1) **B: BHL**

(2) **Drive System**

C: CSTN T: TFT E: OLED M: MONO

(3) **Product Status**

L: LCD Model F: FOG Model G: COG Model P: PANEL Model C: CELL Model

(4) **Display size(精确到小数点后1位,四舍五入)**

EX) 2.22 inch:22 1.76 inch:18 2.0 inch:20 10.1inch:A1
1.9 inch:19 1.12 inch:11 1.8 inch:18 15.5inch:F5

(5) **Resolution**

Number of Row Dots * Number of column Dots(前两位有效)

EX) 128 * 128 = 1212 96 * 64 = 9664 128 * 160 = 1216 101 * 80 = 1080
176 * 220 = 1722 128 * 96 = 1296 320 * 240 = 3224 1024 * 576 = 1057

(6) **Viewing Direction**

Nil: 6 H U: 12 H L: 9 H R: 3 H W: Wide view E: 其他

(7) **Serial Number (*001-9999: 按照产品状态, 各类产品序列号实行大排行处理, *为0时省略不写)**

(8) **Back Light**

Nil: Without backlight + Reflective H: CCFL + Translective
T: Without backlight + Transflective E: LED Frontlight + Reflective
F: CCFL Frontlight + Reflective D: LED + Transflective
L: LED + Transmissive

(9) **DUAL LCD**

Nil: Single LCD M: MONO C: CSTN T: TFT O: OLED

(10) **TOUCH PANEL**

Nil: Without TP P: with TP

Model	BTL221722-276L	17/28	PRODUCT SPECIFICATION
-------	----------------	-------	-----------------------

14. Package Terms

- 1、Tray Size
 L:340mm
 W:248mm
 (12 PCS LCM/Tray)

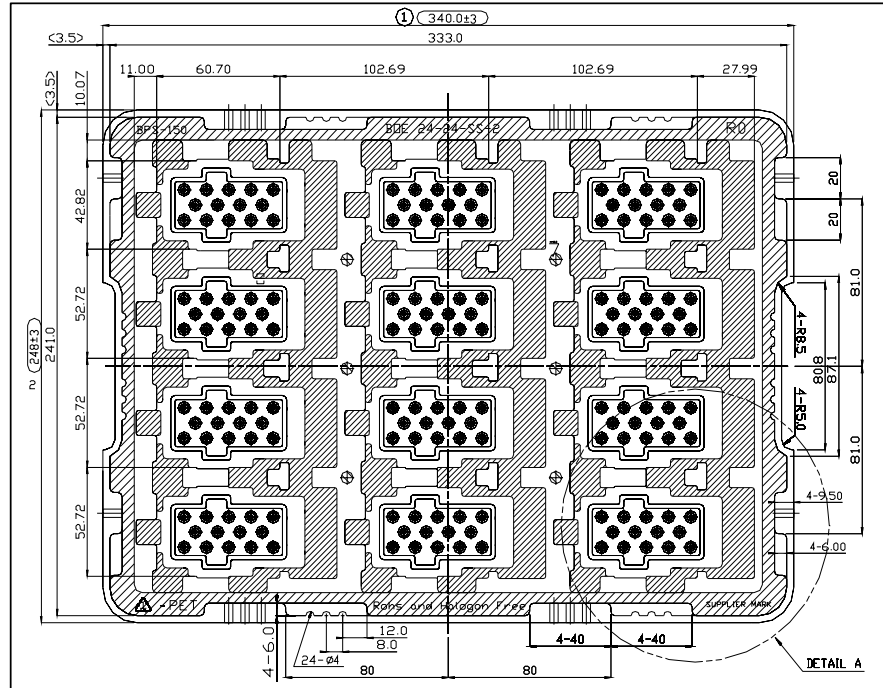

Tray Drawing

- 2、Inner BOX Size
 L:360mm
 W:260mm
 H:80mm
 (7pcsTray/ Inner Box)

Note: there's one empty tray in every inner box.

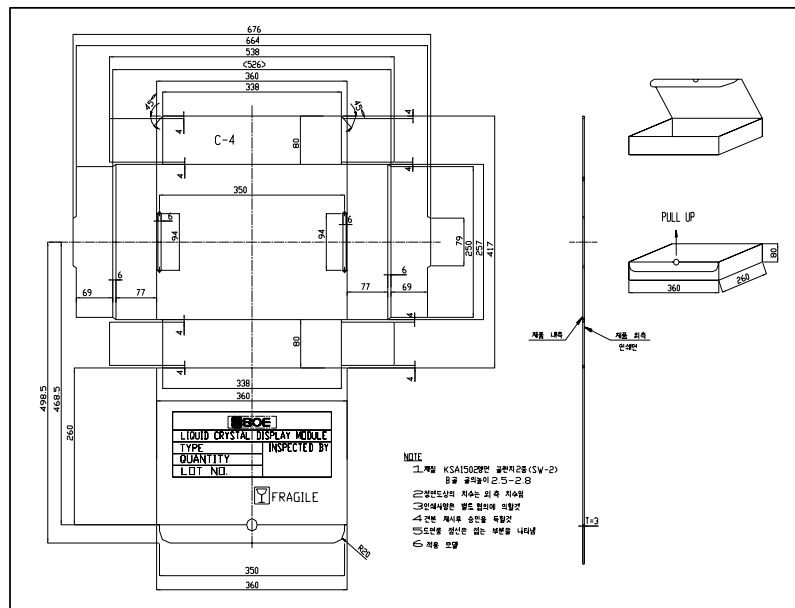

Inner Box Drawing

Model	BTL221722-276L	18/28	PRODUCT SPECIFICATION
-------	----------------	-------	-----------------------

3、Out BOX Size
L: 545mm
W: 380mm
H: 270mm
(6pcs Inner / Out)

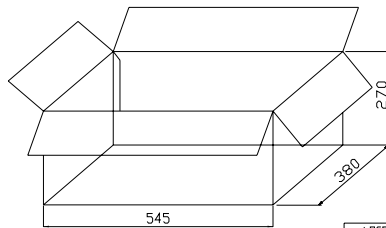
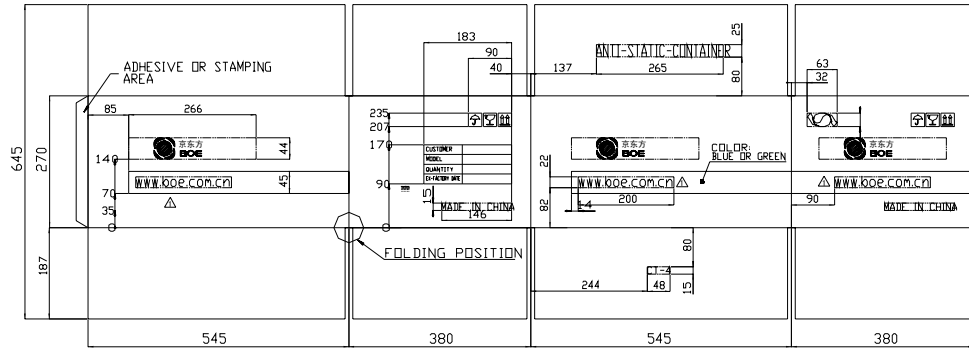

NOTE
 1.MATERIAL: KSA 1531,DW2(T=8mm)
 2.DRAWING DIMESIONS ARE EQUAL TO OUTSIDE DIMENSION.
 3.INNER BOX(C-4) ARRANGEMENT: 3STEPS X2ROWS
 4.MARKS ARE REFER TO SEPERATE CONSULTATION.

LOGO	COLOR
	BLUE OR GREEN
WWW.BOECOM.CN	CLEARNESS
OTHERS	BLUE OR GREEN

4、Packing label content

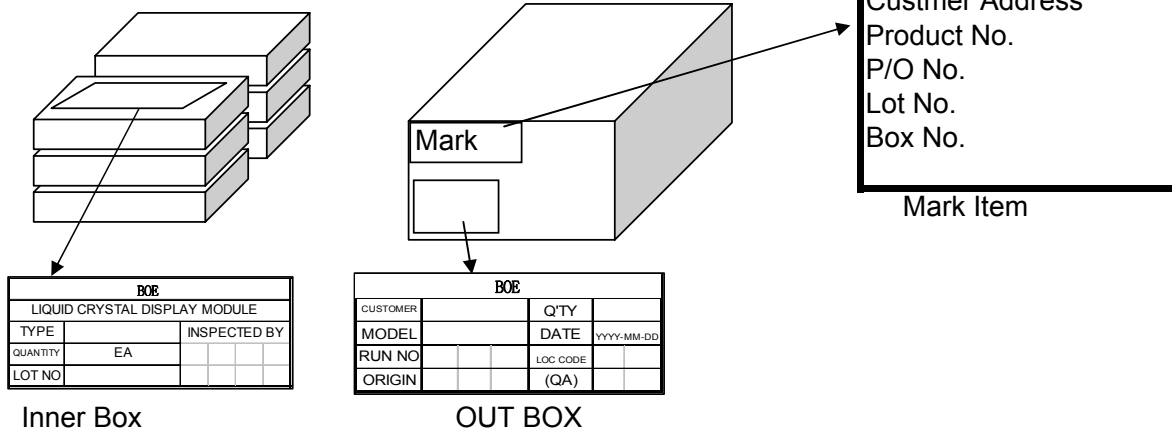

5、Packing notice

- [1]Sub LCD should be placed upwardly while in the tray.
- [2] Every seven full trays with a blank one while twining twice on both sides by adhesive tape.
- [3].Every tray should be put crossedly.

6、Product label

- [1] There should be Logo and product modle of BOE on FPC ASS'Y.

7、Packing Q'ty list

		INNER BOX	TRAY	MODULE
OUT BOX		6	42	432
	INNER BOX	1	7	72
	TRAY	-	1	12

Model	BTL221722-276L	19/28	PRODUCT SPECIFICATION
-------	----------------	-------	-----------------------

15. LCD Module Out-Going Quality Level

(1.0) Purpose

The LCD specification provides outgoing provision and its expected quality level based on our outgoing inspection of LCD.

(2.0) Applicable Scope

The LCD specification is applicable to the arrangement in regard to outgoing inspection and quality assurance after it.

(3.0) Quality Specification

(3.1) Quality Level

The quality level of BHL&BMDT are based on GB/T2828.1, Apply Level II, normal inspection by single sampling.

Rank	Item	AQL	Note
Major(MA)	Segment Short	0.65	
	Segment Missing		
	Solder Bridging		
	Outside Dimension		
	Cold Solder		
Minor (MI)	Black Spots, Foreign Substance, White Spots, Pinhole, Segment Deformation Air Bubbles between Glass & Polarizer, Scratches(Glass & Polarizer), Color Variation, Solder Ball, Misalignment	1.0	

Note) AQL- Acceptable Quality Level

(3.2) Appearance Standards

1) Inspection Conditions

The LCD shall be inspected under 20W white fluorescent lamp light.

The distance between the eyes and the sample shall be 30cm.

All directions for inspecting the sample should be within 30° to perpendicular line.

2) Definition of the Area

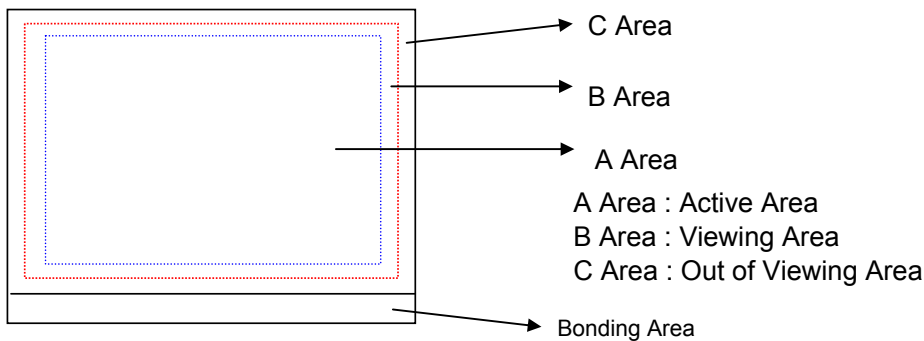

Model

BTL221722-276L



20/28

PRODUCT SPECIFICATION

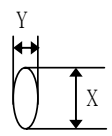
(3.3) Appearance Spec

No	Item	Criteria	Rank	Remark																																													
1	Segment Short Segment Missing	Not allowed	MA																																														
2	Solder Bridging	Any bridging between components, except common circuit, is not allowed.	MA																																														
3	Outside Dimension	Drawing & specification must be within permissible tolerance.	MA																																														
4	Cold Solder	Cold solder is not allowed.	MA																																														
5	Black(White) Spots, Foreign Substances	<p>1) Round Type</p> <table border="1"> <thead> <tr> <th rowspan="2">Area Dimension**</th> <th colspan="2">Acceptable Q'ty</th> <th rowspan="2">Remark</th> </tr> <tr> <th>A Area</th> <th>B Area</th> </tr> </thead> <tbody> <tr> <td>≤ 0.1</td> <td colspan="2">Ignore</td> <td rowspan="4"></td> </tr> <tr> <td>≤ 0.2</td> <td>2</td> <td>Ignore</td> </tr> <tr> <td>≤ 0.3</td> <td>1</td> <td>Ignore</td> </tr> <tr> <td>0.3 <</td> <td>0</td> <td>Ignore</td> </tr> </tbody> </table> <p>2) Liner Type</p> <table border="1"> <thead> <tr> <th colspan="2">Dimension</th> <th colspan="2">Acceptable Q'ty</th> <th rowspan="2">Remark</th> </tr> <tr> <th>Length</th> <th>Width</th> <th>A Area</th> <th>B Area</th> </tr> </thead> <tbody> <tr> <td>-</td> <td>≤ 0.025</td> <td colspan="2">Ignore</td> <td rowspan="4"></td> </tr> <tr> <td>≤ 2.5</td> <td>≤ 0.05</td> <td>3</td> <td>Ignore</td> </tr> <tr> <td>≤ 1.5</td> <td>≤ 0.075</td> <td>2</td> <td>Ignore</td> </tr> <tr> <td></td> <td>0.075 <</td> <td colspan="2">Follow round type</td> </tr> </tbody> </table> <p>At (1) & (2) total defect q'ty is must not exceed 5 pieces.</p>	Area Dimension**	Acceptable Q'ty		Remark	A Area	B Area	≤ 0.1	Ignore			≤ 0.2	2	Ignore	≤ 0.3	1	Ignore	0.3 <	0	Ignore	Dimension		Acceptable Q'ty		Remark	Length	Width	A Area	B Area	-	≤ 0.025	Ignore			≤ 2.5	≤ 0.05	3	Ignore	≤ 1.5	≤ 0.075	2	Ignore		0.075 <	Follow round type		MI	 <p>** : Mean Diameter (X + Y)/2</p>
Area Dimension**	Acceptable Q'ty			Remark																																													
	A Area	B Area																																															
≤ 0.1	Ignore																																																
≤ 0.2	2	Ignore																																															
≤ 0.3	1	Ignore																																															
0.3 <	0	Ignore																																															
Dimension		Acceptable Q'ty		Remark																																													
Length	Width	A Area	B Area																																														
-	≤ 0.025	Ignore																																															
≤ 2.5	≤ 0.05	3	Ignore																																														
≤ 1.5	≤ 0.075	2	Ignore																																														
	0.075 <	Follow round type																																															
6	OC Spot	<table border="1"> <thead> <tr> <th rowspan="2">Area Dimension**</th> <th colspan="2">Acceptable Q'ty</th> <th rowspan="2">Remark</th> </tr> <tr> <th>A Area</th> <th>B Area</th> </tr> </thead> <tbody> <tr> <td>≤ 0.2</td> <td colspan="2">Ignore</td> <td rowspan="3"></td> </tr> <tr> <td>≤ 0.8</td> <td>3</td> <td>Ignore</td> </tr> <tr> <td>≤ 1.0</td> <td>1</td> <td>Ignore</td> </tr> </tbody> </table>	Area Dimension**	Acceptable Q'ty		Remark	A Area	B Area	≤ 0.2	Ignore			≤ 0.8	3	Ignore	≤ 1.0	1	Ignore	MI																														
Area Dimension**	Acceptable Q'ty			Remark																																													
	A Area	B Area																																															
≤ 0.2	Ignore																																																
≤ 0.8	3	Ignore																																															
≤ 1.0	1	Ignore																																															
7	Air Bubles Between Glass & Polarizer (Polarizer Defects)	<table border="1"> <thead> <tr> <th rowspan="2">Area Dimension**</th> <th colspan="2">Acceptable Q'ty</th> <th rowspan="2">Remark</th> </tr> <tr> <th>A Area</th> <th>B Area</th> </tr> </thead> <tbody> <tr> <td>≤ 0.15</td> <td colspan="2">Ignore</td> <td rowspan="5"></td> </tr> <tr> <td>≤ 0.3</td> <td>3</td> <td>Ignore</td> </tr> <tr> <td>≤ 0.5</td> <td>2</td> <td>Ignore</td> </tr> <tr> <td>≤ 0.7</td> <td>1</td> <td>Ignore</td> </tr> <tr> <td>Total</td> <td>5</td> <td>Ignore</td> </tr> </tbody> </table>	Area Dimension**	Acceptable Q'ty		Remark	A Area	B Area	≤ 0.15	Ignore			≤ 0.3	3	Ignore	≤ 0.5	2	Ignore	≤ 0.7	1	Ignore	Total	5	Ignore	MI																								
Area Dimension**	Acceptable Q'ty			Remark																																													
	A Area	B Area																																															
≤ 0.15	Ignore																																																
≤ 0.3	3	Ignore																																															
≤ 0.5	2	Ignore																																															
≤ 0.7	1	Ignore																																															
Total	5	Ignore																																															

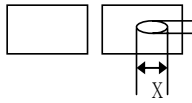
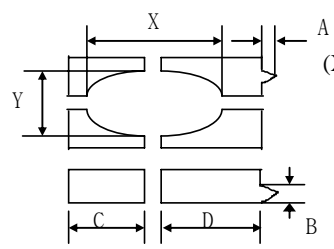
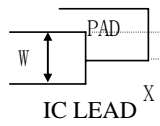

(3.3) Appearance Spec

No	Item	Criteria	Rank	Remark								
8	Pin hole (On Segment)	 <p> $(X+Y)/2 \leq 0.2\text{mm}$ Within 1 per one segment (Less than 0.1mm is not counted) Total defects q'ty is must not exceed 5 pieces. </p>	MI									
9	Segment Deformation	 <p> $(X+Y)/2 \leq 0.2\text{mm}$ $A \leq 0.2\text{mm}$ $B \leq 0.2\text{mm}$ $(C-D) \leq 0.2\text{mm}$ </p> <table border="1" data-bbox="526 750 1125 862"> <thead> <tr> <th></th> <th>Acceptable Q'ty</th> </tr> </thead> <tbody> <tr> <td>Dot, Segment</td> <td>1</td> </tr> <tr> <td>LCD</td> <td>5</td> </tr> <tr> <td>≤ 0.1</td> <td>Ignore all defect</td> </tr> </tbody> </table> <p>Each visible dot must be more than half effective dot area</p>		Acceptable Q'ty	Dot, Segment	1	LCD	5	≤ 0.1	Ignore all defect	MI	$(X + Y)/2 \leq 0.2\text{mm}$
	Acceptable Q'ty											
Dot, Segment	1											
LCD	5											
≤ 0.1	Ignore all defect											
10	Color Variation	Within the three colors, except LCD Standard color is acceptable.	MI									
11	Glass & Polarizer Scratch	Follow NO.5(2) condition	MI									
12	Solder Ball	1)Acceptable if the size of void is less than 0.18mm 2)Acceptable if a solder ball is not movable 3)Rejectable if the solder ball exceed 5EA in $2.54 \times 2.54\text{mm}$ area.	MI									
13	Miss Alignment	1)Acceptable if it dose not exceed 50% of the lead width IC.  <p> $X \leq W/2$: Accept $X > W/2$: Reject </p> 2)Rejectable, provided that it does exceed 50% of the component termination width.  <p> $W1 > W2$: Reject </p>										

Note : A limitation sample is given top priority

Model	BTL221722-276L	22/28	PRODUCT SPECIFICATION
-------	----------------	-------	-----------------------

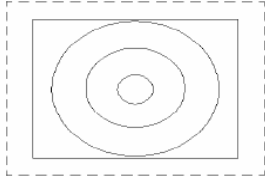
(3.3) Appearance Spec

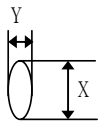
No	Item	Criteria	Rank	Remark																																																
14	Touch Panel	<p>1) Round Type、Foreign Substances</p> <table border="1"> <thead> <tr> <th rowspan="2">Area Dimension**</th> <th colspan="2">Acceptable Q'ty</th> <th rowspan="2">Remark</th> </tr> <tr> <th>A Area</th> <th>B Area</th> </tr> </thead> <tbody> <tr> <td>≤ 0.1</td> <td colspan="2">Ignore</td> <td rowspan="4"></td> </tr> <tr> <td>≤ 0.2</td> <td>2</td> <td>Ignore</td> </tr> <tr> <td>≤ 0.3</td> <td>1</td> <td>Ignore</td> </tr> <tr> <td>0.3 <</td> <td>0</td> <td>Ignore</td> </tr> </tbody> </table> <p>2) Liner Type & Scratch</p> <table border="1"> <thead> <tr> <th colspan="2">Dimension</th> <th colspan="2">Acceptable Q'ty</th> <th rowspan="2">Remark</th> </tr> <tr> <th>Length</th> <th>Width</th> <th>A Area</th> <th>B Area</th> </tr> </thead> <tbody> <tr> <td>-</td> <td>W ≤ 0.025</td> <td colspan="2">Ignore</td> <td rowspan="5">Ignore</td> </tr> <tr> <td>L ≤ 3.0</td> <td rowspan="2">W ≤ 0.05</td> <td colspan="2">Ignore</td> </tr> <tr> <td>3.0 < L ≤ 5.0</td> <td colspan="2">2</td> </tr> <tr> <td>≤ 7</td> <td>W ≤ 0.1</td> <td colspan="2">1</td> </tr> <tr> <td>-</td> <td>W > 0.1</td> <td colspan="2">Follow round type</td> </tr> </tbody> </table> <p>3) Newton Ring</p> <p>a) Regular</p>  <p>The area of the Newton ring is more than 1/3 area of the touch panel It's NG. The area of the Newton ring is less than 1/3 area of the touch panel It's OK.</p> <p>b) None-regularity</p>  <p>The area of the Newton ring is more than 1/2 area of the touch panel It's NG. The area of the Newton ring is less than 1/2 area of the touch panel It's OK.</p>	Area Dimension**	Acceptable Q'ty		Remark	A Area	B Area	≤ 0.1	Ignore			≤ 0.2	2	Ignore	≤ 0.3	1	Ignore	0.3 <	0	Ignore	Dimension		Acceptable Q'ty		Remark	Length	Width	A Area	B Area	-	W ≤ 0.025	Ignore		Ignore	L ≤ 3.0	W ≤ 0.05	Ignore		3.0 < L ≤ 5.0	2		≤ 7	W ≤ 0.1	1		-	W > 0.1	Follow round type		MI	 <p>** : Mean Diameter (X + Y)/2</p>
Area Dimension**	Acceptable Q'ty			Remark																																																
	A Area	B Area																																																		
≤ 0.1	Ignore																																																			
≤ 0.2	2	Ignore																																																		
≤ 0.3	1	Ignore																																																		
0.3 <	0	Ignore																																																		
Dimension		Acceptable Q'ty		Remark																																																
Length	Width	A Area	B Area																																																	
-	W ≤ 0.025	Ignore		Ignore																																																
L ≤ 3.0	W ≤ 0.05	Ignore																																																		
3.0 < L ≤ 5.0		2																																																		
≤ 7	W ≤ 0.1	1																																																		
-	W > 0.1	Follow round type																																																		

(4.0) Reliability Condition

Item	Content
Room Temperature Operation	50,000 hrs

(4.1) Reliability Test - Module Middle Reliability

No.	Item	Condition	Test Time	Sample Numbers	Creteria (Acc/Rej)	Note
1	High Temp Operation	70 ± 2℃	120 hrs	3	0/1	
2	High Temp Storage	80 ± 2℃	120 hrs	3	0/1	
3	Low Temp Operation	-20 ± 2℃	120 hrs	3	0/1	
4	Low Temp Storage	-30 ± 2℃	120 hrs	3	0/1	
5	High Humidity Storage	60℃ 90%rh	120 hrs	3	0/1	
6	Thermal Shock	-25℃(0.5h) ↔ 70℃(0.5h)	20cycle	3	0/1	
7	Vibration Test	To be measured after subjecting to total fixed amplitude of 1.5mm vibrating frequency 10 to 55Hz, one cycle 60 seconds to direction of X,Y,Z for each 15 minutes,(Total 45minutes) and after removing vibration(Non-operation state)				
8	Shock Test (Drop Test)	To be measured after dropping from 60cm high onto steel board of 15mm thick and from 3 direction X,Y,Z each one time (Non-Operation State)				
9	ESD	<ul style="list-style-type: none"> - Condition:150pf, 330Ω, ±8KV, 5 times Air Discharge (ESD which is made by above condition should be shot on LCD glass panel, not other's area(such as on IC and so on) - After testing, cosmetic and electrical defects should not happen. - Total current consumption should be below double of initial value. - In case of malfunction defect caused by ESD damage, if it would be recovered to normal state after resetting, it would be judged as a good part. 				

Model	BTL221722-276L	24/28	PRODUCT SPECIFICATION
-------	----------------	-------	-----------------------

(4.2) Criteria

- a. No. 1 ~ 8 : No changes for indication and appearance.
- b. No. 1 ~ 3, 5 ~ 8 : Leave the all samples under room temperature 4 hours after reliability test ends.
- c. No. 4 : Leave the all samples under room temperature 12 hours after reliability test ends.

16. BHL&BMDT Customer Quality Service Process

In order to provide better service to Customer, BHL&BMDT shall apply the after-sales product quality service process as below:

1. According to the P/O from Customer, BHL&BMDT should deliver required product to the place appointed by Customer.
2. Customer will do IQC for the incoming product.
3. Inspection standard should be provided by BHL&BMDT, and it will be valid after confirmed by Customer. Inspection and Defects determination should be carried out according to the standard agreed by both Parties.
4. In order to guarantee in-time communication of product quality information and effective service, QA staff on Customer side should send Weekly Quality Report to the appointed CS staff in BHL&BMDT.
5. After BHL&BMDT get related information, both sides should arrange time and place to determine the defects found by Customer.
6. BHL&BMDT should cooperate with Customer for special quality requirement.
7. After confirmed by both side, BHL&BMDT should be responsible for the defect products which caused by its quality problem. BHL&BMDT should take back the confirmed defect product and return the good product to the place required by customer.
8. BHL&BMDT agree to provide related training of LCD product technology and usage.
9. Customer should use the LCD product according to the instruction. BHL&BMDT will not be responsible for the defect product caused by violation of Users' Instruction.
10. Both parties should deal with the quality problem with friendly cooperative policy. And both parties should negotiate to deal with the defect products of which the responsibility is not very clear.

Model

BTL221722-276L

26/28

PRODUCT SPECIFICATION

17. LCD Module Operation Instruction

BHL&BMDT

Part I. How to use the LCD Module

1. Don't hit the LCD Panel in any way because the LCD is made of glass.
2. Don't clean the surface of LCD with hard things. Please clean LCD with Air-gun or very soft cloth when necessary. The protective film on the POL can be removed just before assembly, otherwise, dust, spit or other foreign matter may attached on the LCD under the protective film. After the protective film is removed, only air-gun can be used to remove any dust or foreign matter. Fingure or cloth **MUST NOT** be used in such cases.
3. No chemical liquid is allowed to clean the LCD, such as alcohol, acetone and IPA. All of these can damage the LCD. Water on the LCD must be cleaned as soon as possible, for it will cause POL color change or other defect.
4. Please move and assemble LCD very carefully during assembly, and don't push or twist it.
5. Don't damage the FPC of LCD module. It will cause permanent defect.
6. Don't disassemble LCD module. It will cause permanent defect.
7. Don't expose LCD module under sunshine, strong fluorescence or ultraviolet radiation.
8. Please make sure that operators wear static-protective bands effectively and working tables are effectively earthing during operation.
9. Please place LCD module on the tray provided by BHL&BMDT while moving it, in order to avoid mechanical damage. Hold the module's side frames to avoide damage during moving.
10. Don't twist, disassemble, squeeze or hit the PCB. It will damage the circuit or component on PCB and cause functional defect.
11. Please use the connector according to the instruction provided by BHL&BMDT.
12. Please place dual module with the sub-panel upward. Trays should be placed in contrary direction. An empty tray should be placed on the top.
13. Sealing operation on PCB must be very careful to avoid short or cut the original circuit on PCB. Otherwise, it will cause permanant damage to the LCD.
14. Don't add direct DC or high voltage to LCD panel. It will cause functional damage to the LCD or shorten the life of LCD product.
15. LCD may respond slowly or display abnormally in extrem temperature (lower than -20℃ or higher than 50℃). But this doesn't mean LCD functional defect. LCD will display normally in regular temperature. Therefore, don't use LCD product in extrem temperature.
16. Don't push the display area of LCD panel, it will cause abnormal display. This doesn't mean LCD functional defect, neither. LCD will display normally in regular temperature.
17. Electrical test of LCD product is made by using mobile phone provided by Customer. We can use special test equipment to do the test, also.
18. The black band on IC on LCD product is used to protect the IC from light. Please do **NOT** remove it.
19. Please take great care to use connector. Customer should be responsible for connector defect caused by operation on Customer side.

Model	BTL221722-276L	27/28	PRODUCT SPECIFICATION
-------	----------------	-------	-----------------------

Part II Storage

1. Physical status of liquid crystal will change in extrem temperature, and it can not be resumed when the temperature returns to be normal. So LCD module should be stored in required temperature.
2. LCD module should be stored in required humidity. Low humidity may add static, while high humidity may corrode the ITO circuit of LCD product. The suitable storage environment is: temperature: $22\pm 5^{\circ}\text{C}$, humidity: $55\%\pm 10\%$.
3. Don't expose LCD module under sunshine, strong fluorescence or ultraviolet radiation for a long time. It should be stored in dark area.
4. LCD should be stored in static-protective polythene bag. Don't expose it in the air for a long time.

Model	BTL221722-276L	28/28	PRODUCT SPECIFICATION
-------	----------------	-------	-----------------------